



OPERATIONS MANUAL

PC3400



Online Digital Particle Counter

MODEL PC3400

Contents

Contents

CONTENTS	2
SAFETY PRECAUTIONS	5
WARRANTY INFORMATION	6
1.0 GENERAL INFORMATION	7
1.1 BEFORE GETTING STARTED.....	7
1.2 UNPACKING UNIT.....	7
1.3 UNIT LABELING.....	7
1.4 FEATURES AND BENEFITS.....	8
1.5 SPECIFICATIONS.....	8
1.5.1 Power Cable.....	10
1.6 BASIC THEORY OF OPERATION.....	10
2.0 INSTALLATION	14
2.1 WEIR ASSEMBLY.....	14
2.2 MOUNTING.....	15
2.3 WIRING.....	17
2.3.1 Wiring of Mains Power.....	18
2.3.2 Wiring of RS-485 Communications.....	19
2.3.3 Wiring of Ethernet Communications (Optional Feature).....	20
2.3.4 Wiring of Analog Outputs (Optional Feature).....	20
2.4 SAMPLE SETUP.....	21
2.4.1 Sample Considerations.....	21
2.4.2 Sample Taps.....	21
2.4.3 Flow Control.....	22
2.4.4 Flow Control Weir Assembly.....	22
2.4.5 Problems with Air Bubbles.....	23
2.4.6 Sample Flow Startup.....	23
2.4.7 Quick Guide to User Settings.....	23
3.0 PARTICLE COUNTER OPERATION	25
3.1 USER INTERFACE (KEY PAD).....	25
3.2 READOUT / DISPLAY SCREENS.....	26
3.2.1 Main Display Screen.....	26
3.2.2 Total Counts Screen.....	26
3.2.3 Trend Graph.....	26
3.2.4 Status Screen.....	27
3.3 USER MENU / SETUP SCREENS.....	28
3.3.1 User Login.....	28
3.3.2 Sample Setup (Size Ranges, Sample Period & Frequency, Count Format, etc).....	29
3.3.3 General Setup (Analog Outputs, Communication Setup, Log Frequency, etc).....	31
3.3.4 Service Setup (Calibration, Log Erase, Analog Output Calibration).....	33
3.4 RS-485/RS-232 COMMUNICATION AND POWER INDICATORS.....	34
3.5 ROUTINE MAINTENANCE.....	35
3.5.1 Non-brush Cleaning.....	35
3.5.2 Brush Cleaning.....	36
3.5.3 Replacing Tubing.....	37
3.5.4 Replacing Desiccants.....	37
3.5.5 Battery Replacement.....	37
3.6 OPTIONAL FLOW METER.....	38
3.6.1 Tipper Flow Meter Installation.....	39
3.6.2 Magnetic Inductive Flow Meter Installation.....	40
3.6.3 Enabling / Disabling Flow Meter & Count Correction Feature.....	41
3.6.4 Flow Meter Calibration.....	42
3.7 AUTOMATIC SENSOR FLUSH OPTION.....	43
4.0 DOWNLOADING DATA	44
4.1 INSTALLING AND SETTING UP TRACDATA SOFTWARE.....	44
4.2 CONNECTING DOWNLOAD CABLE.....	45

4.2.1	Option 1 - Standard A/B USB Cable	45
4.2.2	Option 2 – RS-232 Download Cable	46
4.3	VERIFYING COMMUNICATION SETTINGS	47
4.4	INSTRUCTIONS FOR DOWNLOADING AND EXPORTING DATA.....	48
4.4.1	Exporting Data.....	49
4.4.2	Erasing Logged Data	50
5.0	RECOMMENDED SPARE PARTS LIST.....	50
5.1	ORDERING SPARE PARTS.....	50
APPENDIX A	51
	USER MENU MAP	51

LIST OF FIGURES

Figure 1 Light Obscuration Measurement (Diagram 1)	11
Figure 2 Particle Size Comparison	11
Figure 3 System Components.....	12
Figure 4 PC3400 and Flow Control Weir Plumbing	13
Figure 5 Weir Assembly	14
Figure 6 Mounting Dimensions	16
Figure 7 Mounting with Weir Arms – Top View.....	16
Figure 8 115/230V and Power Switches.....	17
Figure 9 Warning Label.....	17
Figure 10 Power Terminal Block.....	18
Figure 11 RS-485 Communications.....	19
Figure 12 Optional MODBUS TCP Communications	20
Figure 13 Analog I/O Wiring Terminals.....	20
Figure 14 Sample Tap.....	21
Figure 15 Sensor Flow Rate Adjustment	22
Figure 16 Optional Analog Output Board Installed in Slot A.....	33
Figure 17 Sensor Cleaning Methods	36
Figure 18 Battery Installation	38
Figure 19 Flow Meter Installation & Wiring	39
Figure 20 Automatic Sensor Flush Plumbing & Wiring.....	43

SAFETY

In order to provide maximum user safety, the PC3400 particle counter was designed with the following issues in mind.

- All electrical circuitry is enclosed within a protective non-conductive housing.
- No user serviceable parts.
- No user replaceable parts.
- No access to laser.

SAFETY PRECAUTIONS

It is important to review this list of precautions prior to installation.

- Do not attempt to disassemble the unit.
- Water must not be allowed to enter the housing of the unit.
- Do not remove the protective shield over the AC power input, fuse-holder and transformer without first disconnecting instrument from Mains Power. See Figure 8
- Close and fasten shut the door of the unit prior to any external cleaning to prevent water ingress.
- Do not drop or jar the unit.
- Use a mild non-abrasive cleanser when cleaning the outer cover of the unit.
- Do not modify any internal electrical wiring or electronics.
- The PC3400 sensor is equipped with a class 3R laser and should not be tampered with in any way. The following warning label is affixed adjacent to the laser assembly housing inside of the instrument.

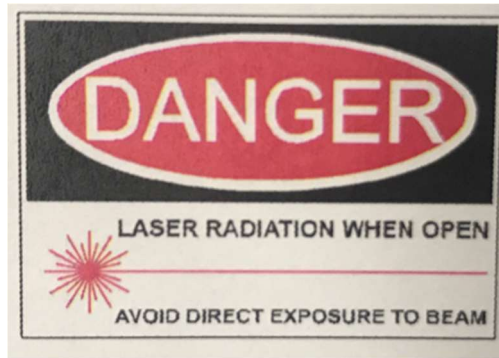

To provide maximum user safety this instrument was designed with all electrical circuitry enclosed within a protective non-conductive housing. The label below will be visible at any location where high voltage is present.

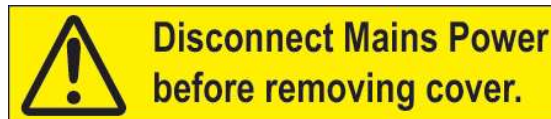

WARRANTY INFORMATION

Chemtrac, Inc. warrants its equipment to be free from defects in material and workmanship for a period of one (1) year from date of shipment to the original purchaser. Upon receipt of written notice from purchaser, seller shall repair or replace the equipment (at option of Chemtrac, Inc.).

Chemtrac, Inc. assumes no responsibility for equipment damage or failure caused by:

1. Improper installation, operation, or maintenance of equipment.
2. Abnormal wear and tear on moving parts caused by some processes.
3. Acts of nature (i.e., lightning, etc.)
4. The sensor optical alignment is very sensitive to vibration. Avoid installation locations with high amounts of vibration. If drilling of enclosure is necessary, please contact the factory for guidance.

This warranty represents the exclusive remedy of damage or failure of equipment. In no event shall Chemtrac, Inc. be liable for any special, incidental, or consequential damage such as loss of production or profits.

Should you experience trouble with the equipment, please contact:

Chemtrac, Inc

1555 Oakbrook Dr, Suite 100
Norcross, GA 30093

Phone: 1-800-442-8722 (Inside US only), 770-449-6233

Fax: 770-447-0889

Email: chemtrac@chemtrac.com

Website: www.chemtrac.com

1.0 GENERAL INFORMATION

1.1 BEFORE GETTING STARTED

NOTE: Do not plug in or power up this unit without first verifying the 115/230 VAC Select Switch is in the proper position (see figure 8). In order to ensure proper operation of the PC3400, it is important to follow the installation guidelines outlined in this manual. Individual plant requirements and layouts will vary, resulting in alterations to the procedures.

In order to achieve and maintain optimal performance, it is imperative that proper installation and operational procedures be followed.

The sensitivity of the unit to small concentrations of particles well below the range of visibility requires that the sample be delivered to the sensor without contamination or alteration. Data produced is based on the sample volume, so flow rate must be maintained at a constant value. The flow path through the sensor is small (750 um x 750 um) in comparison to other types of on-line instruments. Strainers should be used on raw water samples, and a proper maintenance schedule must be followed. Since these instruments count and size particles, each counter produces several channels of data. This data is most useful when trended, so provision should be made for recording and storage.

1.2 UNPACKING UNIT

When unpacking the PC3400 it is important to follow the following guidelines.

1. Open box right side up.
2. Carefully remove and examine packing material for any loose items that may have fallen out of containers during shipping.
3. Carefully remove items from the box. Verify all items listed on the packing list were received. Contact the factory immediately if any items appear to be missing.
4. Your PC3400 may include the following items.
 - Water Weir Kit (if specified) which consists of the following items:
 - o Qty 1 flow control weir PN: 34905
 - o Qty 2 mounting arms PN: 34950
 - o Qty 2 weir clamps PN: 34960
 - o Qty 1 Sample Drain Cup PN: 34970
 - o Overflow Tubing (5/8 in ID X 5 ft) PN: 11430
 - o Weir Inlet & Drain Cup Tubing (3/16 in ID X 5 ft) PN: 11425
 - o Sensor Tubing (1/8" ID x 6 ft) PN: 11420
 - o Qty 1 400 Micron In-Line Strainer (Optional, Recommended For Raw Water) PN: 9875
 - Cleaning Kit which consists of the following
 - o Qty 1 cleaning brush PN: 34400 ***Note that the kit is typically taped to inside of door.**
 - Software (Optional – Download Link Provided When Purchased)
 - o TracData - Data Log Download Software (Optional) PN: 34600
 - Qty 1, Operations Manual

1.3 UNIT LABELING

Each PC3400 particle counter has a serial number label attached to the inside of the front door of the unit. Please refer to this information when inquiring on your unit.

1.4 FEATURES AND BENEFITS

On-line Particle Counter model PC3400 is intended for the determination of particle count and size distribution in a variety of liquid streams. Major applications include monitoring filter performance in potable water treatment plants, detecting contaminants in clean liquids, detecting particle size growth as a function of flocculation or precipitation, detecting particle shedding in medical device testing, and measuring suspended metal oxide corrosion products in steam Generation power plants. Particle counting is generally more sensitive than turbidity measurements for early detection of process changes such as filter breakthrough or contamination of an ultrapure liquid. **Note:** Particle Counters are not suitable for measuring unfiltered raw surface water if turbidity is known to exceed 2.0 NTU. At this level of turbidity or slightly above, the particle concentration will become too large and exceed the limits of the particle counter.

The sensor is designed to detect particles in the 2 to 750 μm range (upper limit defined by flow cell size), and size particles in the 2 to 125 μm range (any particles larger than 125 microns will be sized as $>125 \mu\text{m}$). The PC3400 uses a light blockage method to determine particle size and count. The light source is an infrared laser diode.

The analyzer features an entirely external sampling and measurement system which prevents sample leaks from damaging sensitive electronic components. The 750 μm x 750 μm flow cell is easy to access and clean. The constant head, flow control weir ensures stable, reproducible flow and accurate particle counts.

The PC3400 has a LCD backlit display which allows the user to see the individual size ranges and particle counts in each range. The display also provides the cell condition readout, which is an indication of the sensor's cleanliness and allows the user to know when cleaning is necessary. It is recommended to clean the sensor when the cell condition drops below 90%, or when it drops by more than 10% from the reading obtained after the previous cleaning.

Integration to the customer's SCADA / DCS can be accomplished either via analog 4-20 mA outputs, or by using the digital communication features. RS/485 and RS/232 communication ports are standard on the PC3400. An Ethernet connection is optional. Using these communication ports, the customer can communicate to the PC3400 via Modbus (RTU, or TCP). Option for Profibus is also available (contact factory for more details).

The PC3400 has a built in data logging feature that allows the unit to record over 60,000 sample strings. A single sample string includes size bins, counts in each bin, cell condition, and laser condition. The data is downloaded to a computer using TracData. Chemtrac's data download utility software. Once downloaded, the data can be exported to a spreadsheet program such as Excel. For instant trend viewing, a graphical trend of the last 60 recorded readings is also provided on the unit's display.

Another unique feature of the PC3400 is its ability to perform Automatic Sizing Calibration via the user menu and front panel keypads. No software or computer is required to calibrate the PC3400.

1.5 SPECIFICATIONS

GENERAL

Laser Type:	Solid-state Laser Diode (780nm)
Flow cell Dimensions:	750 μm x 750 μm
Cell Material:	Nituff™ coated aluminum (or PEEK plastic – Optional)
Viewing Windows:	Sapphire
Detection Range:	2-750 μm

Sizing Range:	2-125 µm
Flow rate:	75 m/min
Size Channels:	8, user-selectable
Count Format:	User selectable: Counts per ml, Counts per 100 ml, or Raw Counts
Laser Diode Life:	MTBF > 75,000 @ 55°C
Measurement Type:	Volumetric, counts/mL
Local Display:	Graphical, 8 size channels displayed at once, unit info/diagnostic screen.
Display Readout:	Size channel, counts, cell condition (0-100%), laser condition (0-100%), unit address, # of stored data records, sample period, sample frequency, flow rate
Data Storage:	>60,000 Sample Strings, User defined logging interval (1-254 minutes)
Graphical Trending:	Last 64 recorded readings, User selectable value trending (e.g., Total Counts, Bin 1, Cell Condition, etc)
Keypad Interface:	All instrument settings may be modified via the keypad interface, including instrument calibration (some settings require password)
Serial Communication:	2 wire RS485 (Network) and RS232 (Local)
Communication Protocols:	Standard: MODBUS RTU (RS485, RS232). Optional: MODBUS TCP (Ethernet), PROFIBUS DP
Analog Outputs:	2, 4, 6 or 8 channels, 4-20 mA (optional)
Alarm Relays:	2 Dry Contact Relays, 250V, 5A (optional)
Power Requirements:	115 VAC, 0.2 A, 47-63 Hz or 230 VAC, 0.2 A, 47-63 Hz
Operation Temperature:	32° - 120° F (0° - 50° C)
Dimensions:	12" W x 11" H x 5" D (305 mm W x 280 mm H x 127 mm D)
Weight:	7 lbs (3.2 kg)
Enclosure Rating	Nema-4 / IP-65 (Unused Cable Glands Must Be Plugged, otherwise Nema-3, IP-63)

SAMPLE REQUIREMENTS

Sample Temperature:	32-120° F, (0-50° C), (non-freezing)
Sample Head:	30" (762 mm) water min.

CALIBRATION

Standards:	Latex (PSL) microspheres. Standard sizes used for factory calibration: 2, 3, 5, 7, 10, and 15 µm (nominal)
Recommended calibration frequency:	Yearly

TracData COMPUTER REQUIREMENTS

Operating system:	Windows XP, Vista, 7, 8, 10
Computer:	Intel or AMD processor (2 GHZ or faster); at least 2 GB of RAM, 4 GB of hard drive space

1.5.1 Power Cable

**CABLE MINIMUM
TEMPERATURE RATING 50° C**

Power Cable (not supplied with units shipped outside North America)

3-Core Round	
CMA Ref. No.	2182Y
Bar Code No.	H03VV-F
BASEC approved	
CSA:	0.5mm ²
Current Rating:	3A
Voltage Rating	300/300/V
Nominal Dia.:	5.8mm

1.6 BASIC THEORY OF OPERATION

The Chemtrac Model PC3400 particle counter is designed to "count" particles 2 to 750 micron in diameter and "size" (i.e., sort by size) particles ranging from 2 to 125 microns in diameter. Particles larger than 125 microns will be sized as >125-micron particles. Particles are divided into size ranges and the number of particles counted in each of these ranges can be reported as counts per milliliter, counts per 100 milliliters, or Raw Counts.

The particle counter consists of an optical sensor and counting electronics. The sensor consists of a 780 nm infrared laser diode, a light detector, and two transparent "windows". The detector converts light energy into electrical voltage. The laser light is directed through both windows and on to the detector. Sample flow passes between the windows, so that any particles in the sample will pass through the laser beam. Each particle will block a small percentage of the light that hits the detector, changing the electrical output of the detector. Since the particles are moving rapidly, each particle will produce a short electrical pulse at the output of the detector. The amplitude of the pulse correlates to the size of the particle. The output of the sensor is a stream of pulses of varying amplitude, each corresponding to a particle. This type of device is known as a light blocking or light extinction sensor, see Figure 1.

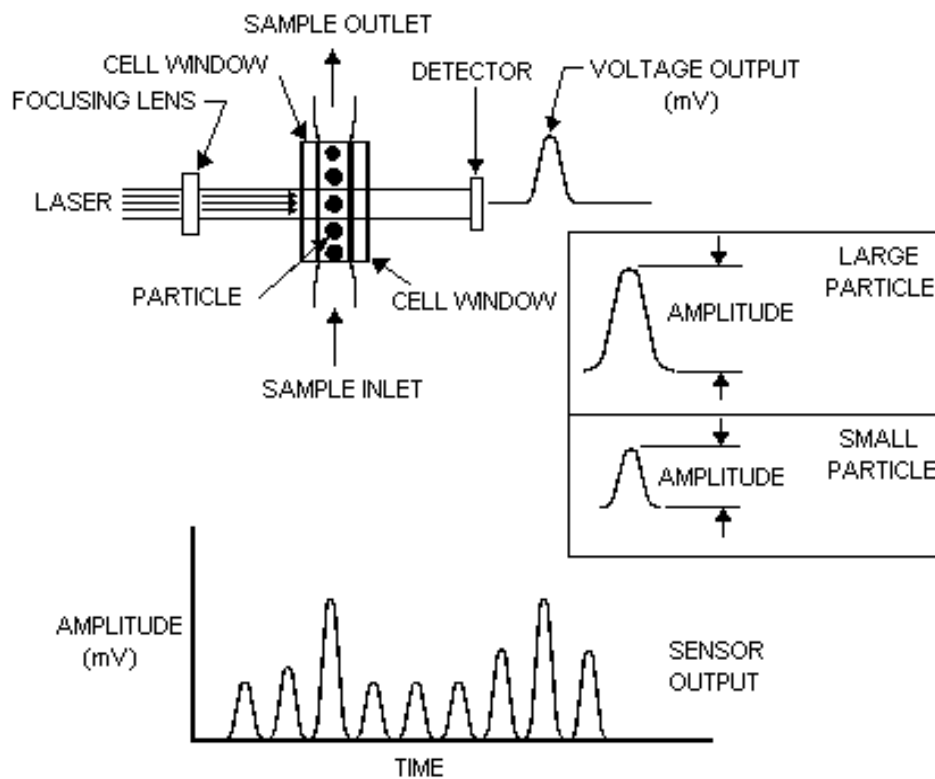

Figure 1 Light Obscuration Measurement (Diagram 1)

The amount of light blocked from the detector is the sum of the light absorbed by the particle and the light scattered or reflected by the particle. The size and composition of each particle will determine how much light is scattered and how much is absorbed. Carbon particles will absorb most of the light and scatter very little of it. Organic particles have an index of refraction close to the value of water and tend to refract more light. The result of this is that an organic particle 5 microns in size will block less light than an inorganic particle of the same size and will appear smaller to the particle counter. For this reason, Giardia and Cryptosporidium will be counted in size ranges several microns below their actual size. The orientation of the particle as it passes through the light beam will also affect how much light is blocked. These factors make it necessary to count particles over a range of sizes as opposed to an exact size.

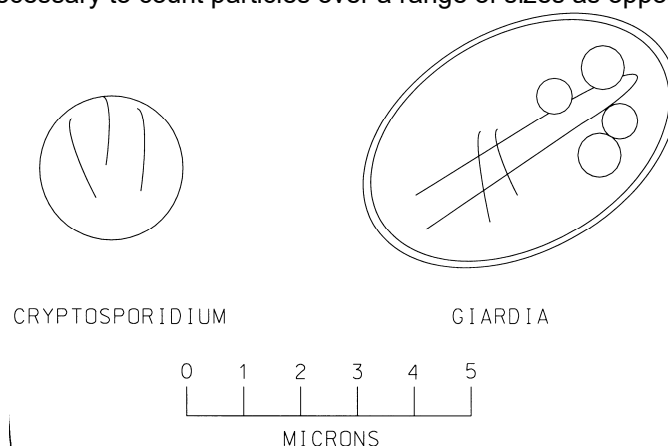

Figure 2 Particle Size Comparison

The sensor output is fed into the counter electronics, which sorts the pulses according to amplitude and counts them. In a typical application, three or four ranges might be used. The first one might be set to count particles in the range from 2 to 5 microns, the second 5 to 10, the third 10 to 15, and so on.

The Model PC3400 typically operates at a flow rate of 75 ml/min. The Flow Control Weir, which is a constant head overflow device, is used to maintain this flow. Flow adjustment is accomplished by moving the drain cup up or down the weir assembly, which decreases or increases flow (See Section 2.4.4). Other flow rates can be used and are set via the user menu. However, the instrument is calibrated at the factory for a flow rate of 75 ml/min and the sizing accuracy will not be accurate if that flow rate is changed by more than 10% and the unit is not recalibrated at the new flow rate. If your application requires the flow the sensor to be something different than 75 ml/min, then contact the factory for assistance.

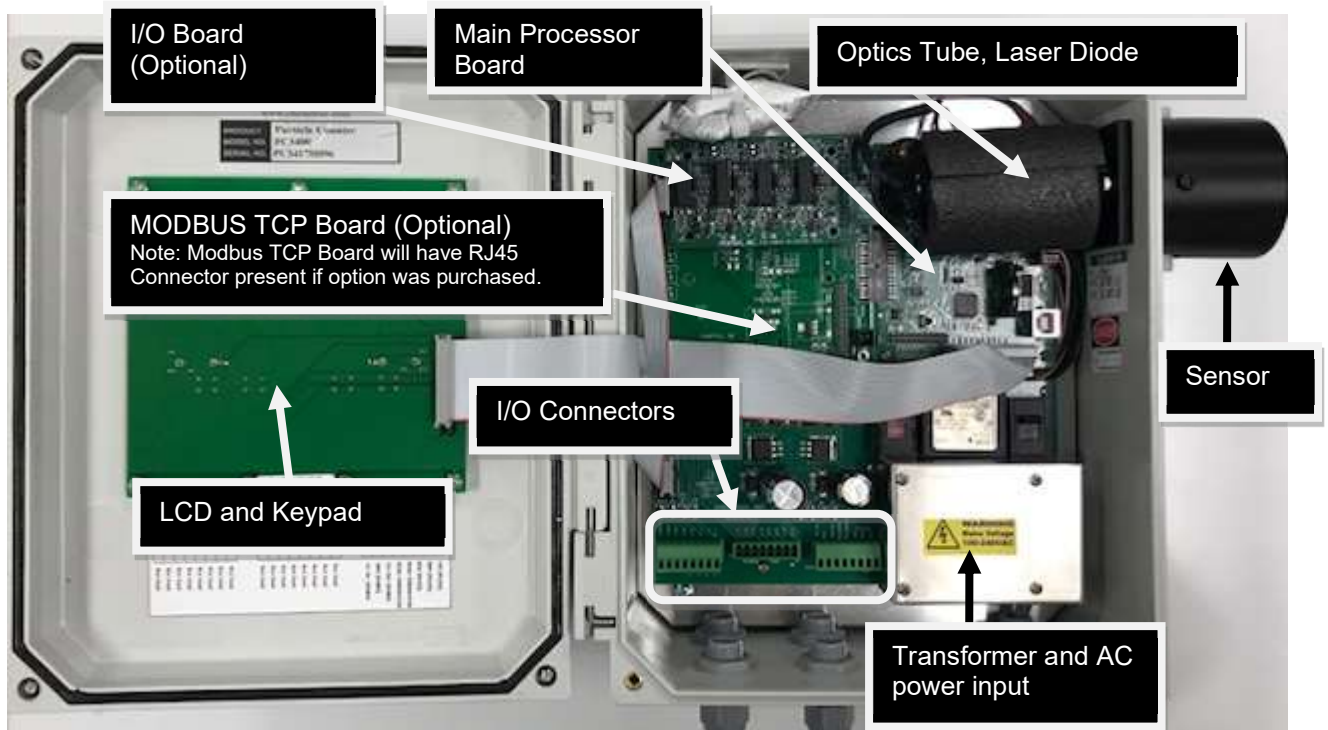

Figure 3 System Components

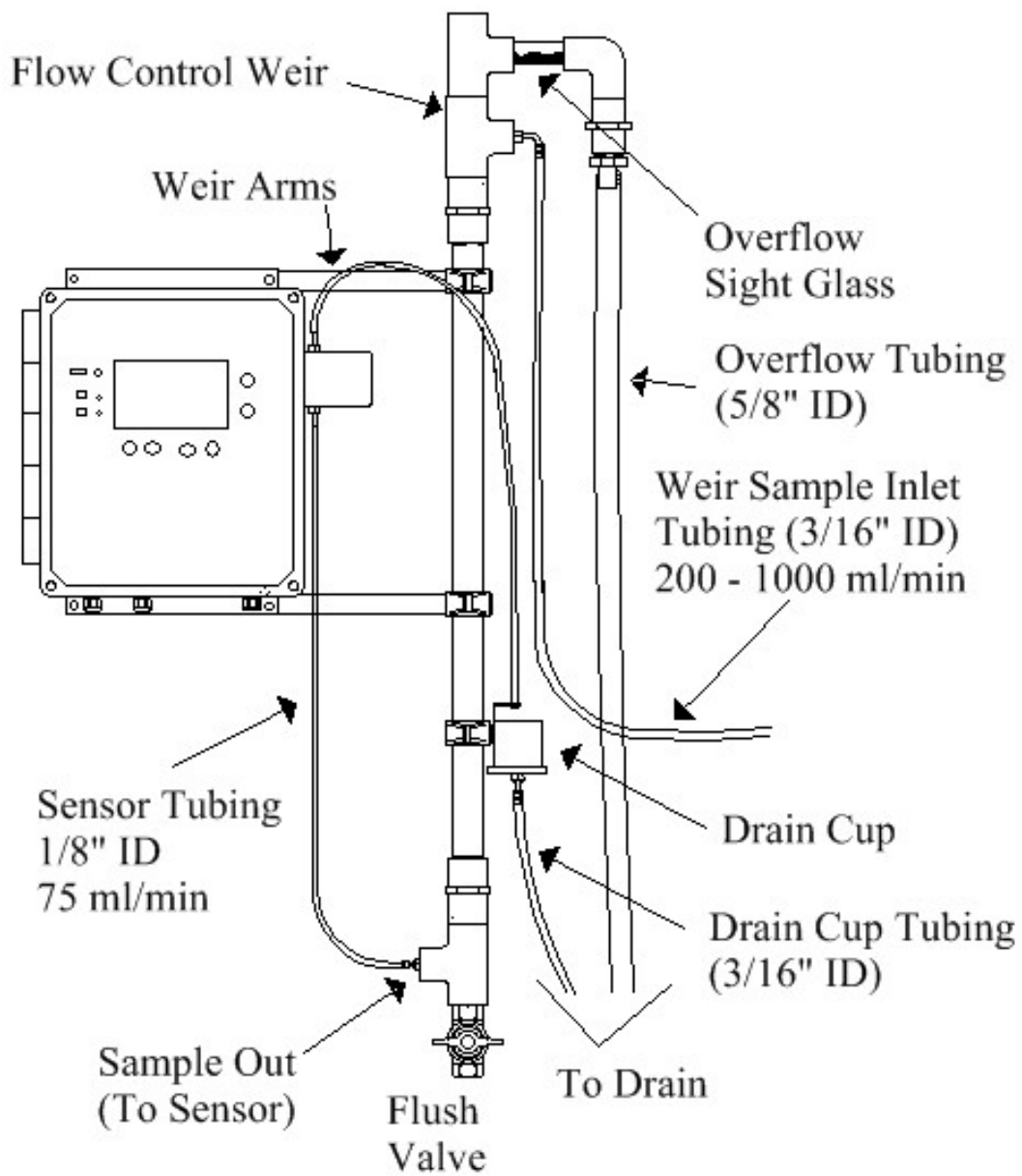

Figure 4 PC3400 and Flow Control Weir Plumbing

Note: See section 3.6 for optional flow meter installation, and section 2.7 for optional sensor flush valve installation.

2.0 INSTALLATION

NOTE

While installing the PC3400, avoid excessive vibration, dropping, or banging on the unit. The optics inside the sensor can be knocked out of alignment if the unit is improperly handled.

2.1 WEIR ASSEMBLY

Prior to mounting the PC3400, it will be necessary to assemble the weir. The weir comes unassembled in three pieces. Those three pieces are simply screwed together to look like the weir shown in the below diagram. Note: See section 2.6 for optional flow meter installation and section 2.7 for optional sensor flush valves installation.

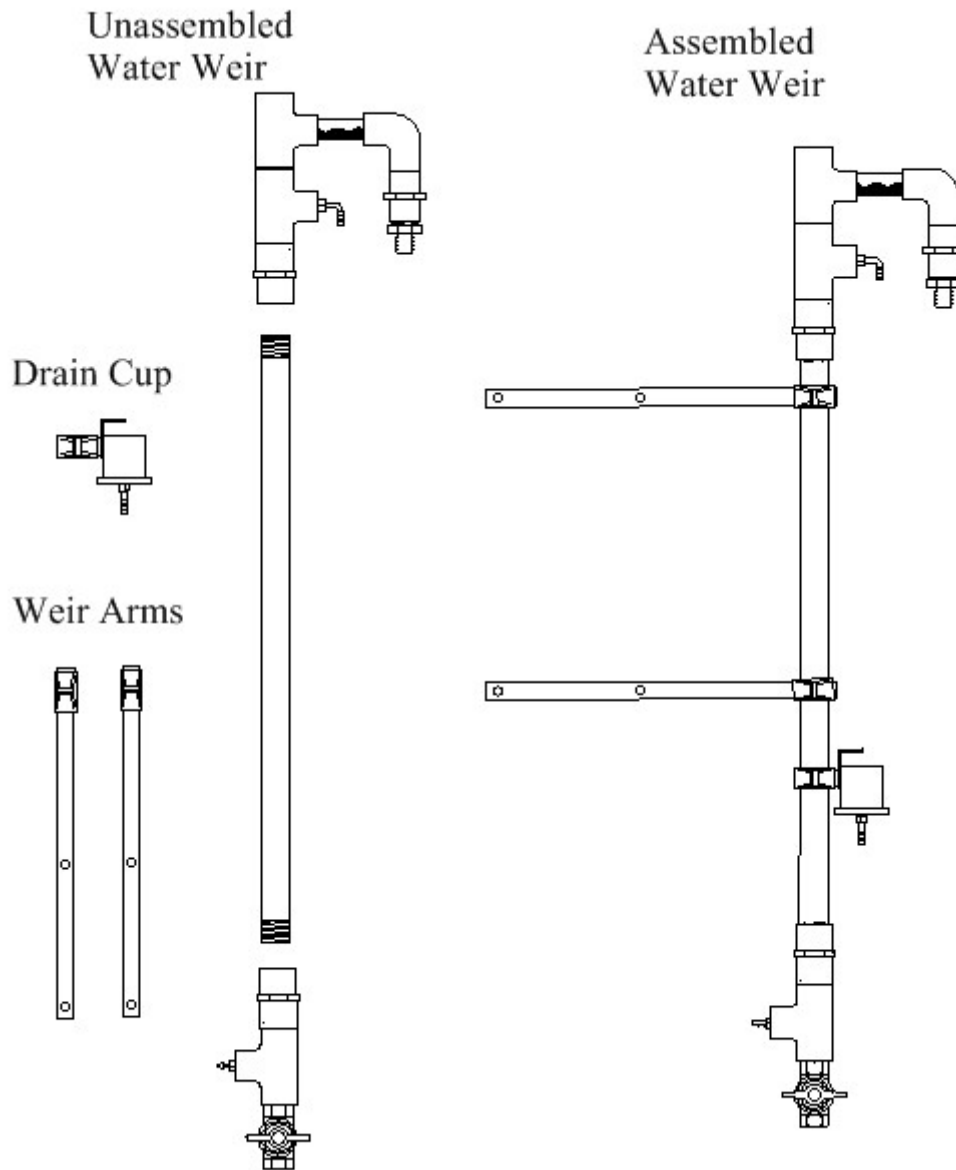

Figure 5 Weir Assembly

2.2 MOUNTING

See Figures 6 and 7 for mounting details. The total space needed to mount the PC3400 is an area 23 inches wide and 43 inches tall. The PC3400 should be permanently mounted to a flat, vertical surface, such as a wall or support column, in an upright position using the 4 mounting holes located at the top and bottom of the counter. The mounting hole dimensions are 6.0 inches horizontally and 10.75 inches vertically and the holes have a 3/8" diameter. The minimum recommended screw/bolt size for mounting the particle counter is 1/4". The mounting hardware is not included with the instrument.

The weir mounting arms should be mounted behind the PC3400, utilizing the same mounting holes, with the weir height adjusted so that the top of the weir is approximately 10 to 12 inches above the top of the PC3400.

The weir assembly and PC3400 should be mounted at an elevation sufficient to achieve overflow at minimum source pressure. A ball valve can be used to regulate the flow into the weir assembly.

IMPORTANT NOTE ON WEIR INSTALLATION

Weir arms are provided to help simplify the mounting of the Weir. However, some users prefer to mount the Weir directly to a back plate versus using the Weir arms. Not using the weir arms can make it easier to remove the PC3400 if the equipment needs to be serviced. If the weir arms are not to be used, just ensure two things:

1. Make sure the clear horizontal pipe at the top of Weir is higher than the top of the PC3400 by 10 to 12 inches. This ensures flow will start reliably through the sensor. If the Weir is mounted too low, the flow may not re-start reliably through the sensor if flow was ever lost for any reason.
2. Mount the Weir to the right of the unit (as shown in figure 17) and insure there is a minimum of 4 inches between the Weir and the sensor (the sensor protrudes from the top right side of the enclosure). The cap on the sensor may need to be removed at some point for maintenance and mounting the Weir too close to the sensor will make it impossible to remove the cap without first removing the weir.

Once the PC3400 and Flow Control Weir are mounted, the tubing can be attached to the Weir and Sensor as detailed in Figure 4. Make the sensor tubing going between the sensor and drain cup long enough to reach the drain cup with it slid all the way down on the weir. It is also recommended to leave a little extra tubing on the bottom of the drain cup. Final adjustment to the drain cup position and tubing lengths will be made in section 2.4.4.

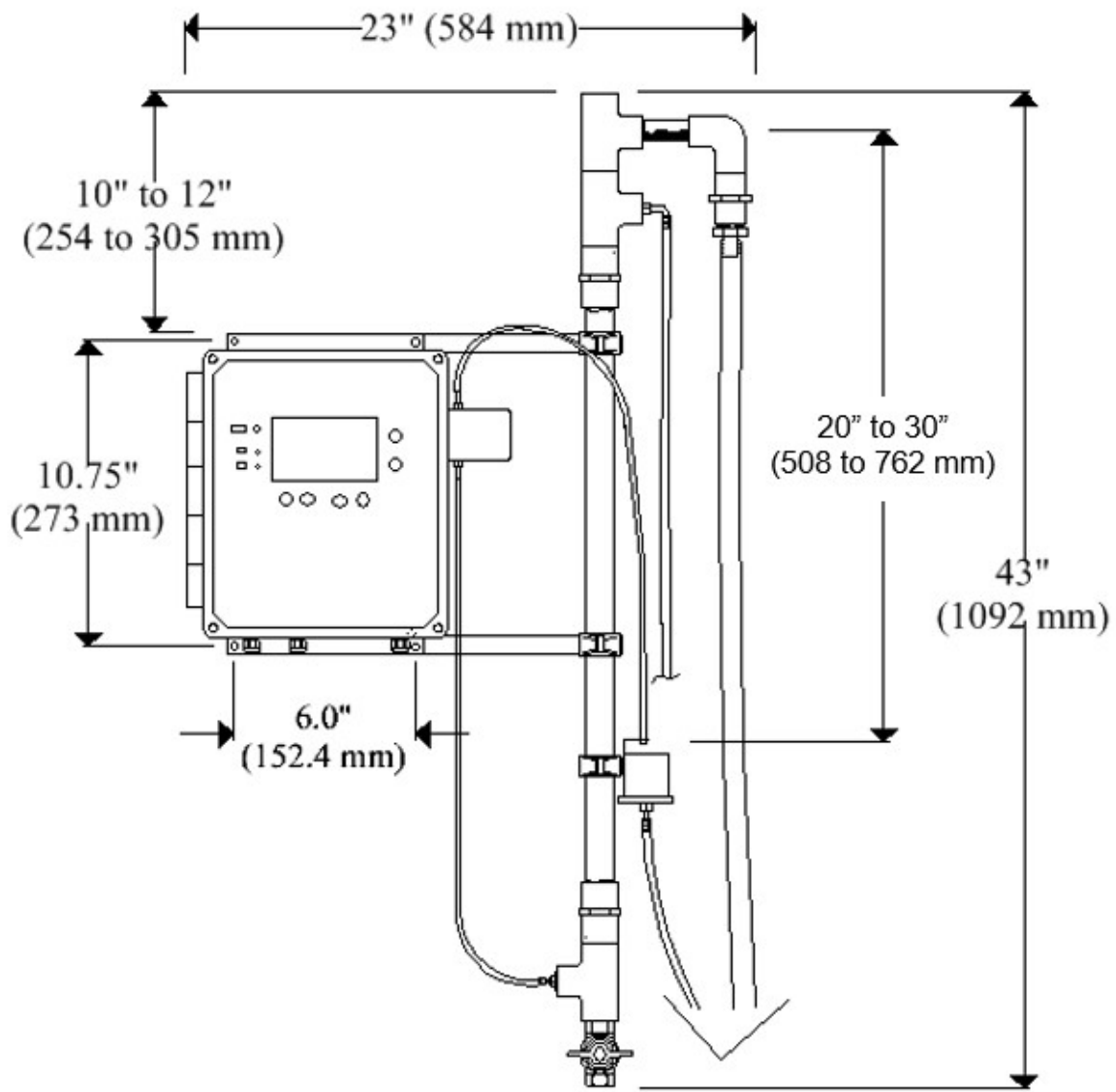

Figure 6 Mounting Dimensions

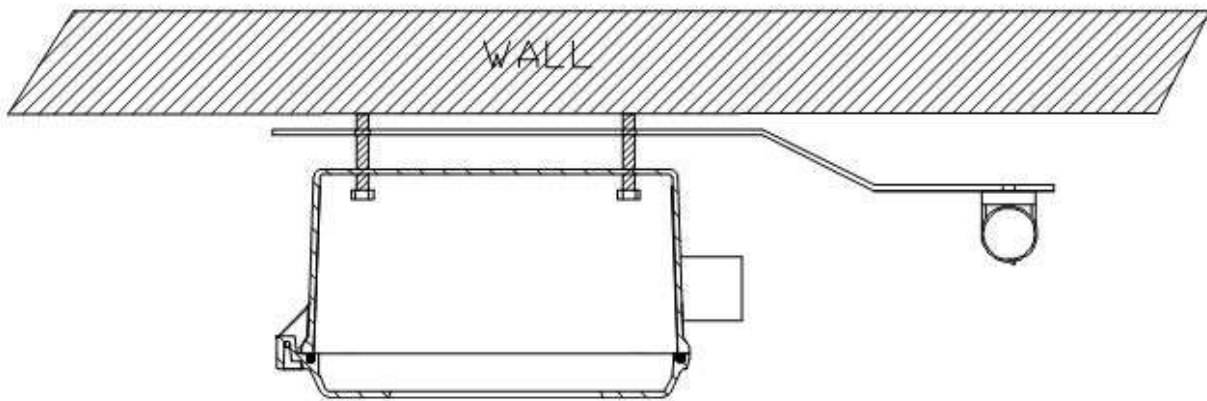

Figure 7 Mounting with Weir Arms – Top View

2.3 WIRING

WIRING SAFETY - Please observe the following safety precautions prior to wiring the unit.

- ❑ All cables must meet the minimum temperature rating of 50 degrees Celsius.
- ❑ Power must be locally fused or switched prior to entering the unit.
- ❑ Power should be hardwired to the unit. Flexible power cords are not recommended around water.
- ❑ Disable power circuit prior to hardwiring the unit or at any time prior to removing the protective shield.
- ❑ Observe polarity when connecting the unit. The unit will not work and can be damaged if polarity is crossed.
- ❑ All wire connections must be tinned prior to connecting to ensure proper contact and to prevent corrosion.
- ❑ The unit must be connected to an Earth Ground. Note: Poor grounding can produce electrical noise in the instrument which could affect the instrument's accuracy.
- ❑ If using the original power cord supplied with your unit, make sure the proper AC voltage is set on the 115/230 VAC Select Switch. Once checked for proper AC power requirements, remove **WARNING!** Label to gain access to the power ON/OFF switch (see Figures 8 and 9).
- ❑ When selecting proper mains voltage, ensure the appropriate fuse has been installed. For 115VAC – 1 Amp GMA Fuse, for 230VAC – 0.5 Amp GMA.

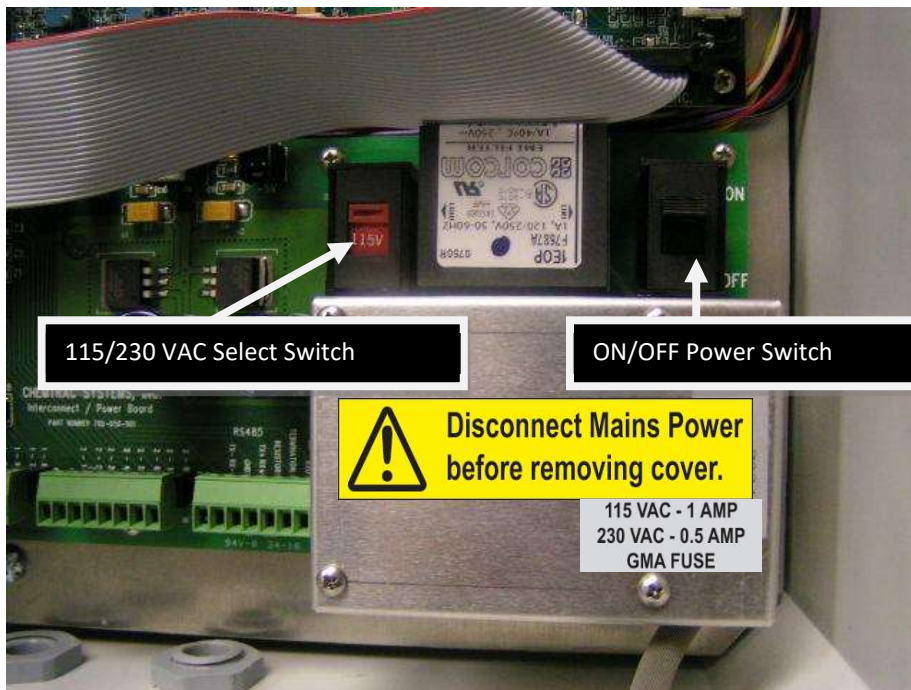

Figure 8 115/230V and Power Switches

Figure 9 Warning Label

NOTE

The particle counter is one of the most sensitive and precise on-line instruments in use in water treatment today. In order to achieve and maintain optimal performance, it is imperative that proper installation and operational procedures be followed.

2.3.1 Wiring of Mains Power

Following the installation, guidelines outlined in this manual should result in proper operation with minimal problems. Individual plant requirements and layouts will vary, resulting in alterations to the procedures.

1. Open the enclosure by first unscrewing all 4 screws on the front cover.
2. Locate the 115/230 VAC select switch and verify it is in the proper position for your mains power.
3. Remove the 4 screws that hold the aluminum protective cover and unplug the 3-position green connector to gain better access to the connector screws.
4. During installation, a local isolation point must be supplied.
5. Disable the power circuit that will be used to supply power to the unit.
6. With the power off, feed the electrical supply line through the compression fitting on the bottom right side of the unit.
7. Electrical power should be connected as shown in Figure 10. On the PC board, under the green connector, it is labeled from left to right, "NEU", "GND", and "HOT".

NOTE

When feeding wire into unit it is always important to feed through the compression fitting that is closest to that wire connection.

- Insert the neutral wire into the left terminal labeled "NEU".
- Insert the ground (earth) wire into the middle terminal labeled "GND".
- Insert the hot wire into the right terminal labeled "HOT".

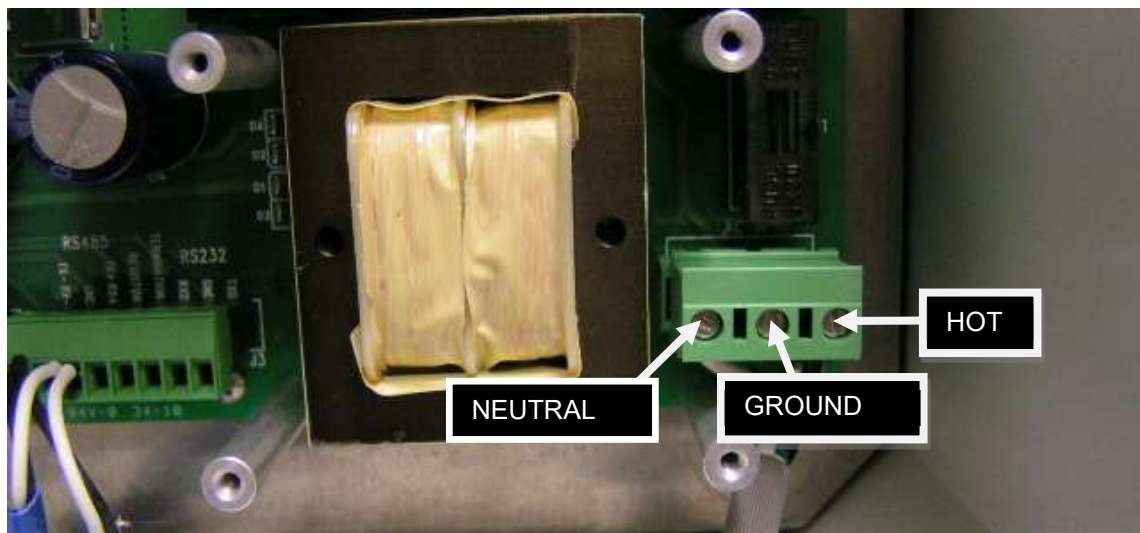

Figure 10 Power Terminal Block

After wiring of mains power is complete, and after verifying the 115/230 VAC select switch is in the right position, enable the external power circuit and flip the "On/Off" switch to the "On" position and verify the PC3400 display comes on.

2.3.2 Wiring of RS-485 Communications

□ RS 485 Communications Cable Recommendation

Cable should be 24 AWG twisted pair with a shunt capacitance of 16 pF per foot (max) and 120-ohm characteristic impedance (max). Belden 9841 (specifications below) is suitable to use.

Belden Wire & Cable – Paired Cable	
For Low Capacitance for EIA RS-485 Applications	
Trade Number:	9841
NEC	CM
UL AWM	2919
CEC	CM
Conductor AWG:	24
Conductor Stranding:	(7x32)
Conductor DCR:	78.7 ohms/km
Conductor Type:	TC
Insulation Type:	Polyethylene
Jacket Type:	PVC
Shield Type:	Beldfoil® + TC Braid
Nominal OD:	0.232" (5.893mm)
Nominal Capacitance:	12.8 pF/ft. (42.0 pF/m)*
Nominal Capacitance:	23.0 pF/ft. (75.5 pF/m)**
Velocity of Property:	66%

When utilizing RS-485 Communications, connect the RS-485 Cable to the RS-485 terminals on the PC3400 shown below. Ensure shielding is tied together and connected to ground at one end, preferably at the RS-485 module.

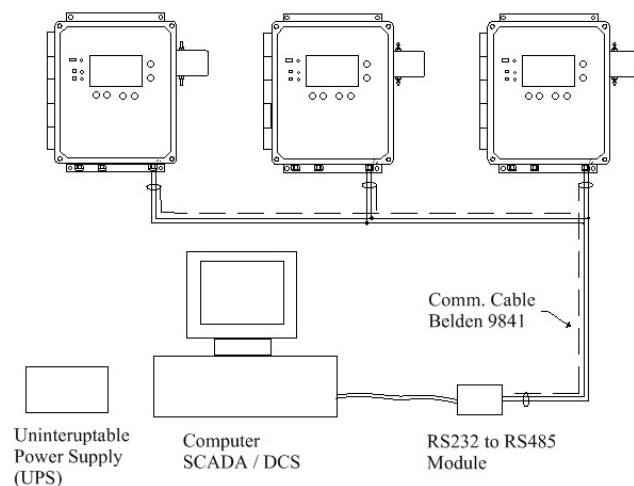
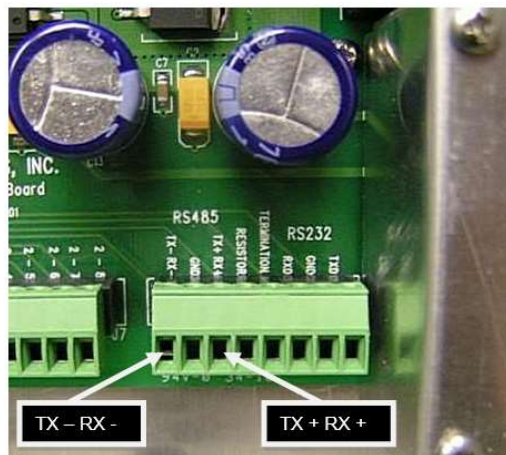

Figure 11 RS-485 Communications

Note

Ninety-six particle counters can be multi-dropped on a RS485 serial communications loop. The maximum network length is 4000 ft. To avoid problems with communications, be sure to contact the factory to discuss how the RS/485 network will be laid out in the plant.

2.3.3 Wiring of Ethernet Communications (Optional Feature)

The optional MODBUS TCP card with RJ45 connector (PN: 34791) is required to utilize the optional Ethernet Communication capability. The location of the MODBUS board and RJ45 connector are shown below. Route the CAT5 cable with RJ45 male connector through the strain relief fitting located on the bottom of the PC3400 enclosure and connect it to the female RJ45 connector as shown.

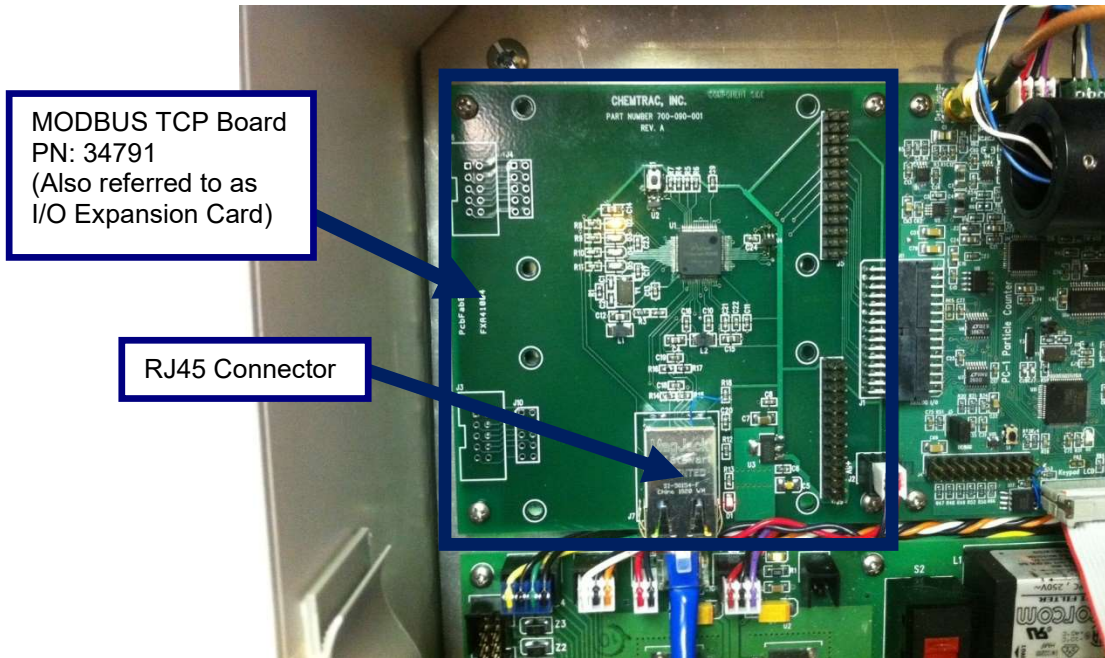

Figure 12 Optional MODBUS TCP Communications

2.3.4 Wiring of Analog Outputs (Optional Feature)

When utilizing 4-20 mA outputs, the signal wiring will be done at terminals J6 (Analog One) and J7 (Analog Two). Because of the variety of Analog I/O options available, it is not practical to identify the precise wiring locations in the scope of this manual. A label adhered to the inside of the door of each PC3400 will indicate the precise wiring locations for any optional I/O included with each individual particle counter. Note: The I/O card installed in Slot A is generally wired to Analog One (J6) and Slot B is generally wired to Analog Two (J7). For example, a 4-channel analog output card installed in Slot A would typically be available on J6, and Output #1 would be on terminals 1-1 (+) and 1-2 (-), Output #2 on terminals 1-3 (+) and 1-4 (-), Output #3 on terminals 1-5 (+) and 1-6 (-), and Output #4 on terminals 1-7 (+) and 1-8 (-). **Note: Outputs are internally powered, do not apply power to output terminals.**



Figure 13 Analog I/O Wiring Terminals

2.4 SAMPLE SETUP

2.4.1 Sample Considerations

The high sensitivity of the particle counter makes sample handling and delivery critical for proper operation. Poor sample point selection and/or improper sample line installation can result in a substantial loss of accuracy.

It is not difficult to achieve proper sample delivery in virtually any treatment plant. The important thing is to make sure the sample is properly representative of the process stream. There are three ways in which the sample can be distorted:

1. Adding particles to the sample stream. Choosing an improper location for the sample tap, such as the bottom of a pipe where sediment can accumulate, or an open sample point where particles can be introduced from outside the process usually causes this.
2. Losing particles from the sample stream. Long sample lines can cause particle dropout, especially at low flow rates. If the sample line must be long (more than 10 or 15 feet) then it will be important to keep the sample flowing swiftly (i.e. 4 ft per second) to prevent particulate from settling out in the tubing. The higher flow rate will also help keep the tubing cleaner and thereby help minimize particle shedding which can be caused by fluctuations in flow.
3. Altering the particle distribution. Sample pumps can chop up larger particles creating more small particles. Valves and other obstructions can cause "shedding". Particles collect on cracks and edges and then break loose later. "T" fittings can cause larger particles to miss the sample line because they can't make the sharp right angle "turn".

Of course, it is seldom possible to avoid all of these pitfalls. Frequently valves are needed to control sample flow rates, or pumps are used to get the sample to a usable point. The important thing is to minimize these problems. Filtered water can be pumped with fewer problems than raw or settled, since only very small particles are usually present, and they are less likely to be broken up. Ball valves or other types with minimal edges to trap particles can be used. "Y" fittings can be used instead of "T"s".

2.4.2 Sample Taps

The diagram below (Figure 14) shows proper and improper sample locations on a process pipe. These are the same as for any instrument requiring a representative sample flow.

Make sure that the sample point has the minimum pressure available at all times to provide enough flow. The Chemtrac sensor requires approximately 2 feet of head to maintain a 75-ml/min flow, so ensure there will be a minimum of 2 feet of head throughout the entire filter run (i.e., during high head loss towards the end of filter run).

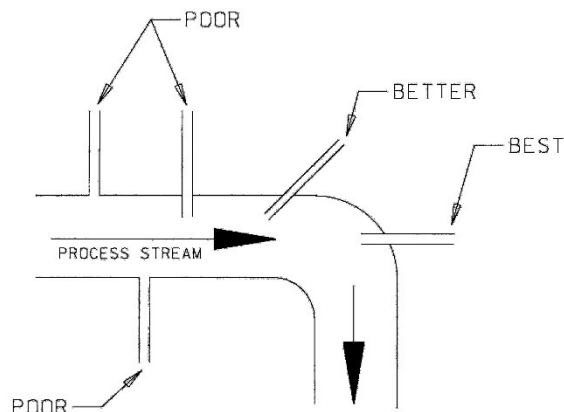

Figure 14 Sample Tap

2.4.3 Flow Control

Particle count data is calculated based on a sample volume; thus, flow control is crucial to accurate and repeatable performance. The simplest and most effective way to achieve constant flow is using the flow control weir. As standard, the Chemtrac particle counter comes equipped with a sample drain cup as shown below.

Note: If the particle counter was supplied with an optional flow meter, see section 3.6 before proceeding onto section 2.4.4. If the particle was supplied with sensor flush option, see section 3.7 before proceeding onto section 2.4.4.

2.4.4 Flow Control Weir Assembly

The flow control weir assembly is designed to deliver constant flow to the sensor despite changes in source pressure. Overflow (as seen through the clear horizontal pipe) must be maintained to ensure that full flow is achieved. The clear horizontal pipe at the top of the assembly gives an indication of the amount of overflow. If the level in this pipe reaches the top, or if there is no overflow at all, the flow to the sensor will be affected. It is best to keep the overflow at the midpoint in this pipe to allow for variations in source pressure. An inlet flow to the weir of at least 200 mL/min and not greater than 1000 ml/min should be delivered to the weir to ensure proper flow through the sensor.

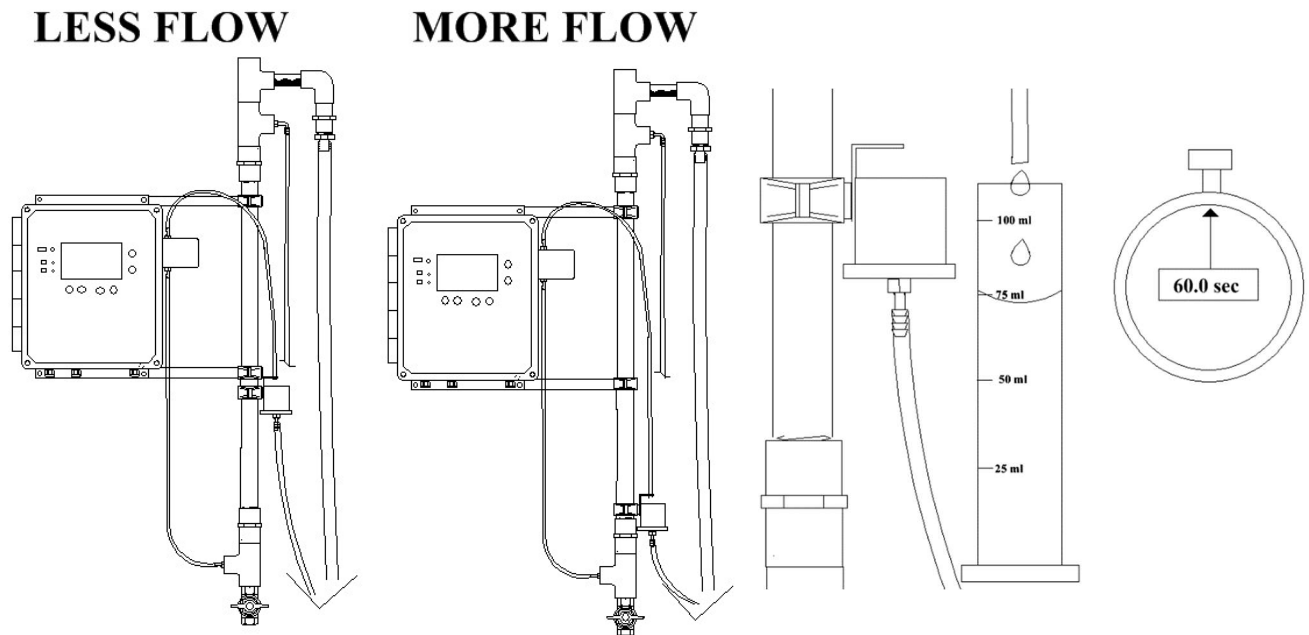

Figure 15 Sensor Flow Rate Adjustment

The flow rate through the sensor is adjusted by moving the Drain Cup up or down the vertical pipe until a 75 ml per minute flow is achieved. Measure the flow rate using a graduated cylinder and a stopwatch. Once the flow is set, the flow will remain stable as long as some amount of overflow is maintained at the top of the weir. As seen in figure 6, the head required to achieve the 75 ml/min flow rate is approximately 20 to 30 inches (as measured from the clear horizontal pipe down to drain cup's tubing holder). Changes in water temperature, as well as the sensor & tubing getting dirty, will affect the flow rate.

As part of the regular maintenance cycle, periodic checks should be made to the flow rate. If the flow rate is found to be low, try replacing the sensor tubing if it looks dirty and clean the sensor as outlined in section 3.5. If this maintenance action does not achieve the proper flow rate, then adjust the Drain Cup up or down the weir to obtain the proper flow rate of 75 ml/min.

2.4.5 Problems with Air Bubbles

Bubbles can be introduced into the sample through various means (air in-leakage from loose fittings, degassing from temperature changes and/or pressure changes, etc.). The particle counter will count bubbles as particles if they are large enough, just as a turbidimeter will detect air bubbles as turbidity.

The flow control weir is designed to aid in the removal of air bubbles. However, air bubbles that have formed due to degassing are difficult to remove using the flow control weir. In some cases, the sample may need to be kept pressurized through the sensor to avoid the formation of bubbles. Contact the factory for assistance if you suspect air bubbles are interfering with the measurement. Air bubbles forming in the sensor tubing is a possible indication that air bubbles may be a problem.

2.4.6 Sample Flow Startup

It is important to flush the sample lines before connecting sample to the particle sensor to help avoid plugging. Once sample is hooked up to the sensor, allow 15 to 30 minutes for the readings to stabilize.

With water flowing through the sensor, a check should be performed to make sure the new PC3400 has a laser and cell percentage reading of 95 to 105% as seen on the Status screen (press the down arrow to access the status screen) and that counts appear on the results screen. 95 to 105% is the expected cell and laser % range for a new and clean sensor only, these values will change as the sensor ages (laser % will increase and cell % will decrease). NOTE: The laser and cell percentage are temperature dependent. If water and/or air temperature is <40 F or >90 F, then 90 to 100% is the acceptable range.

2.4.7 Quick Guide to User Settings

Below is an overview of the most common settings that users may need to customize to their application.

1. **Size Ranges.** Up to 8 size channels (or “Bins”) can be programmed into the PC3400 using size ranges from 2 to 125 micron. Enter the desired size ranges to be measured by going to Menu > Sample Setup > Size Ranges. Note: To use less than 8 size bins, input a “0” after the last desired size range is entered. See section 3.3.2.4 for more info.
2. **Sample Frequency.** Sample frequency determines how often the PC3400 will perform a measurement. The default and recommended sample frequency for most applications is 60 seconds. If a different sample frequency is required, go to Menu > Sample Setup > Sample Frequency and enter the desired setting. The minimum recommended sample frequency is 30 seconds. Note: Sample frequency must be greater than sample period. Sample frequency and sample period settings have no impact on the sensor life. See section 3.3.2.3 for more info.
3. **Sample Period.** Sample period determines the length of time that the sample is measured. The default and recommended sample frequency for most applications is 15 seconds (or 30 to 60 seconds when using “ppb readout” option). If a different sample period is required, go to Menu > Sample Setup > Sample Period and enter the desired setting. Note: Sample period must be less than sample frequency. Using a longer sample period can help to smooth out readings. See section 3.3.2.2 for more info.
4. **Count Format.** Multiple count formats are available including “counts per mL”, “counts per 100 mL”, and “raw counts”. If the PC3400 has the optional “ppb readout” feature, additional count formats like “counts per mL + pbb” will be available. Go to Menu > Sample Setup > Count Format to select the desired count format. See 3.3.2.7 for more info.
5. **Flow Setup.** The flow setup menu should only need to be accessed if using Chemtrac’s optional flow meter. To enable the optional flow meter, go to Menu > Sample Setup > Flow Setup and select “Flow Meter” and then press enter. Next, enter the target flow rate as 75 ml/min and press enter. On the last screen the user can enable the Count Correction feature. Count Correction should only be enabled after the user has calibrated the flow meter (see section 3.6 for instructions on calibrating the flow meter). To disable the flow meter, repeat above steps and change “Flow Meter” to “Fixed Rate” selection and then press enter. Then enter 75 ml/min as the flow rate and press enter. See 3.3.2.5 for more info.

6. **Time and Date.** Go to Menu > General Setup > Time and Date to enter the local time and today's date.
7. **Analog Outputs - Mapping & Scaling.** If using the optional analog outputs, the user will need to map the desired parameters (e.g., Bin 1 Counts, Total Counts, Cell %, etc.) to the available analog outputs by going to Menu > General Setup > I/O & Alarms and then perform Output Mapping, followed by Output Scaling. When mapping or scaling the outputs, the user may be prompted to enter a "Slot" identification (A or B). To determine whether analog outputs exist on Slot A and/or Slot B, open the enclosure and locate the card(s) in the top left-hand corner. The below photo shows an example of I/O card with 2 analog outputs and 2 relays installed in Slot B, while Slot A is shown empty. In other cases, there may only be an analog output card in Slot A while Slot B is empty, or both slots may be equipped with I/O cards (type, number, and location of I/O cards depends on I/O options that were specified by the customer). See section 3.3.3.4 for more info.

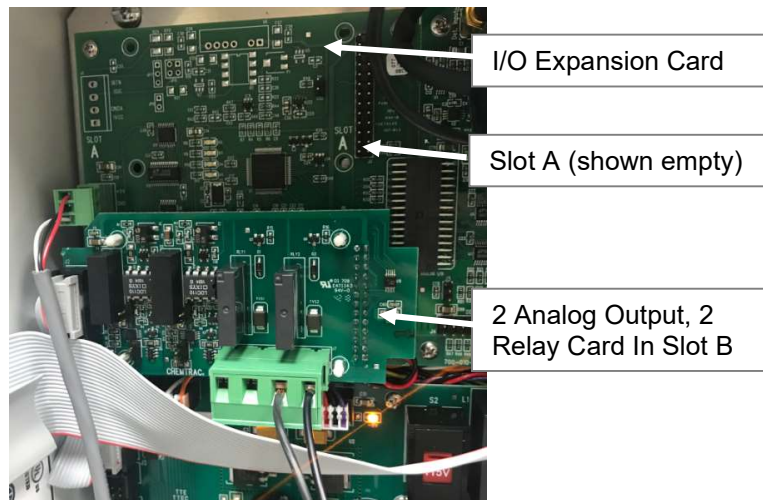

8. **Analog Output Wiring.** See section 2.3.4.
9. **Analog Output Calibration.** The analog outputs can be calibrated by going to Menu > Service Setup > Manual Calibration > Output Adjust. See section 3.3.4.1.1
10. **Modbus Communications.** If using the Modbus RTU (RS-485) or optional Modbus TCP (Ethernet) communication, the user will need to setup the appropriate serial communication settings or IP settings by going to Menu > General Setup > Communication Setup. Note: For optimum communications reliability, the recommended poll frequency for the PC3400 is 0.5 seconds max. See section 3.3.3.5 for more info.

3.0 PARTICLE COUNTER OPERATION

3.1 USER INTERFACE (Key Pad)

The PC3400 is equipped with user interface keys, and LED indicators. The interface keys are up (▲), down (▼), left (◀), right (▶), and the Menu and Enter function keys. On power up, you see the screen below. In the Appendix of this manual there is a flow chart of display and menu screens.

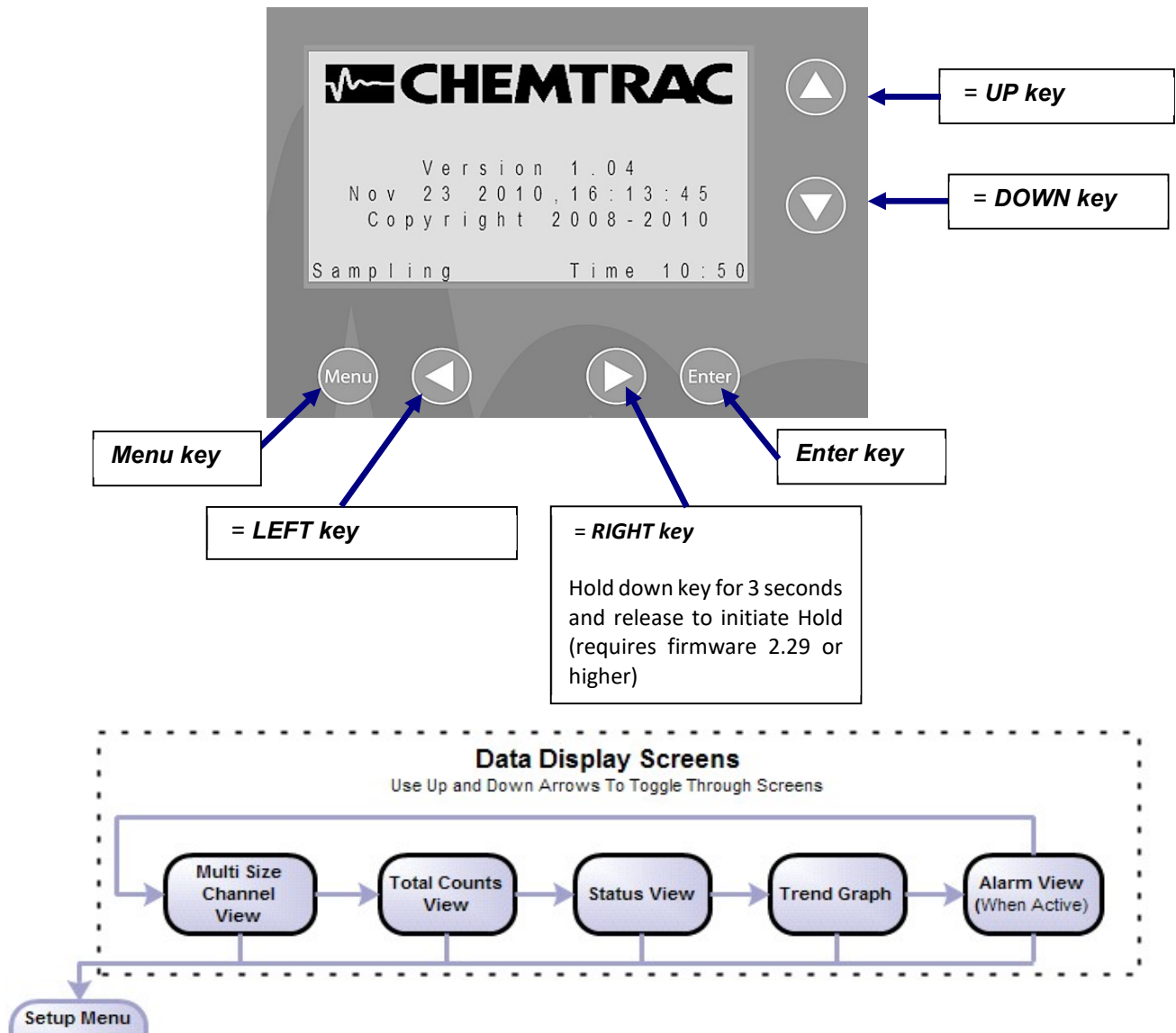

There are three LED lights to the left of the graphical display. These are:

- ❑ Power – Red LED that illuminates when there is power to the unit.
- ❑ TX – Yellow LED that illuminates when the unit is transmitting data.
- ❑ RX – Green LED that illuminates when the unit is receiving data.

3.2 READOUT / DISPLAY SCREENS

3.2.1 Main Display Screen

Upon completion of first sample period, the screen will update with the measurement results broken out by size range.

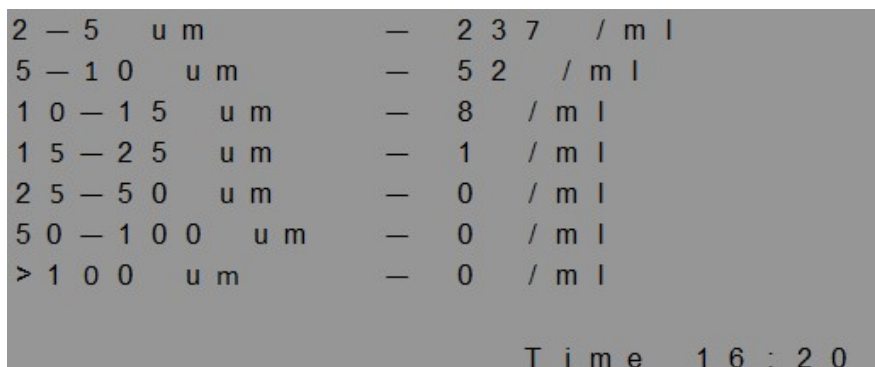

3.2.2 Total Counts Screen

Press the **Down Arrow** to view the Total Counts screen.

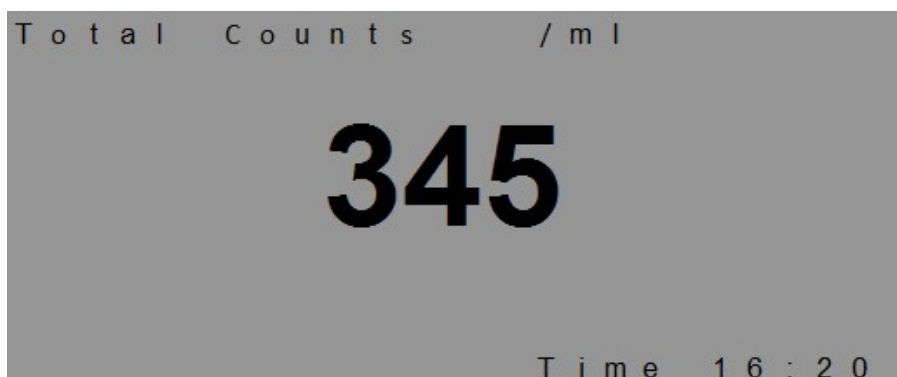

3.2.3 Trend Graph

Pressing the **Down Arrow** key again will bring up the Trend Graph screen. The cursor (the down arrow in the screen) can be moved across the graph by the left and right arrow keys. The samples viewed are the last 64 samples that are logged. Any of the logged values can be mapped to the Graph via the User Menu. This includes Total Counts, individual Bin counts, Cell Condition, etc.

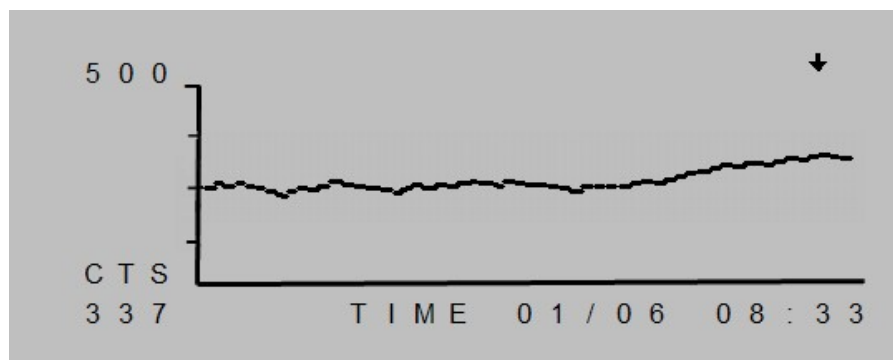

3.2.4 Status Screen

Pressing the **Down Arrow** key again will access the Status Screen.

S T A T U S	
U n i t : 1	V e r : 1 . 0 7 h
S a m p l e # : 3 1 2	
M e m o r y : 4 5 %	D a y s : 2 5
S a m p l e P e r i o d : 1 5	
S a m p l e F r e q u e n c y : 6 0	
L a s e r : 1 0 0 %	C e l l : 9 8 %
F l o w R a t e : 7 5 m l / m i n	
S a m p l i n g	T i m e : 1 6 : 2 0

Unit Address: The unit's unique address which is used to identify the unit for digital communications (e.g., MODBUS RTU).

Ver: Shows the firmware version the unit is programmed with.

Sample #: Number of measurements taken since the unit was last powered on. This number will rollover back to 1 when the number reaches 1440. This number will reset to 1 whenever an "Exit & Save" is performed from the menu. The main purpose of the Sample # is just to provide an indication that the PC3400 is performing measurements at the proper interval.

Memory / Days: The PC3400 can hold up to 65,000 data strings stored in internal memory and the % value shown here indicates how full the memory is. The "Days" readout indicates how many days until the memory will be full.

NOTE: Once the memory is 100% full, the PC3400 will display "Overwrite". This indicates that the PC3400 is writing the newest data over top of the oldest data in memory. Data that is written over will not be available for download. After downloading data, the user can erase the memory by going to Menu>Service Setup>Resets>Erase Data Memory.

Sample Period: Number of seconds that a measurement lasts. Default value is 15 sec.

Sample Frequency: Number of seconds between the start of measurements. Default value is 60 sec.

Laser: Percentage readout reflecting changes in laser operating current. This value is provided for diagnostic information only. Laser current will change as a function of laser temperature and age. The laser percentage will increase over the lifetime of the laser and also when ambient air or water temperature increases. With yearly calibrations, a laser percentage between 90 to 115% is considered normal.

Cell: Percentage readout reflecting the cleanliness of the sensor. The sensor should be cleaned after there has been a 10% decrease following the previous cleaning. Note: Changes in temperature which affect the laser percentage will also have an effect on the cell percentage. When the laser percentage drops as a function of cooler temperatures, a corresponding drop in the cell percentage is to be expected. With yearly calibrations, a cell percentage between 90% to 110% after cleaning is considered normal.

Flow Rate: Shows the fixed flow rate value entered into menu (under Sample Setup > Flow Setup) or displays actual flow when optional flow meter is used. Note: Standard factory calibration is performed at 75 ml/min. The user can change the Flow Rate value via the User Menu, but particle sizing may not be accurate if the unit has not been calibrated at that flow rate.

3.3 USER MENU / SETUP SCREENS

NOTE:

The PC3400 will not communicate (RS232, RS485 or Ethernet) nor will it perform any measurements while in the Setup menu. The PC3400 will exit the menu and return to normal operation if the unit is left in the Setup menu for 5 minutes with no activity.

NOTE:

Particle Counters with firmware version 2.0 or later will not have the “Exit and Save” option. On these models, all setting changes in the menu will be saved to permanent memory when the menu is exited. Units with firmware version prior to 2.0 may have the “Exit and Save” option. If “**Exit and Save**” appears on your menu, it must be selected in order to store any changes that were made to permanent memory. Alternatively, if the Menu is exited by pressing the Menu button and not selecting “Exit and Save”, then changes will be saved to temporary memory only and will be lost if the power is cycled off and on.

Press the **Menu** button to access the PC3400 **SETUP** screen.

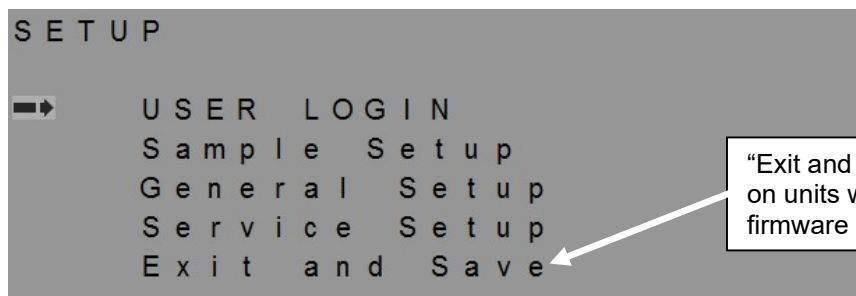

“Exit and Save” will only appear on units with older version firmware (versions prior to 2.0).

3.3.1 User Login

NOTE:

User Login is disabled by default which means user has access to all menu functions. To enable User Login, go to Service Setup > Resets > Tech User Login. A 4-digit login code will be needed to enable the Login. The unit comes from the factory with a default code of “1234” which can be changed once the Login is Enabled. Be sure to record this code in a secure place. If the code is forgotten, contact the factory for assistance.

If the User Login is enabled, then any user who doesn't have the login code will only be able to perform two functions:

1. Change Trend Graph mapping.
2. Turn on the Output Hold so cleaning can be performed without disrupting the output signals (4-20mA, Modbus, Data Log).

3.3.2 Sample Setup (Size Ranges, Sample Period & Frequency, Count Format, etc)

From the top Setup menu move the arrow down to “Sample Setup” and press **Enter**. You should see the below screen.

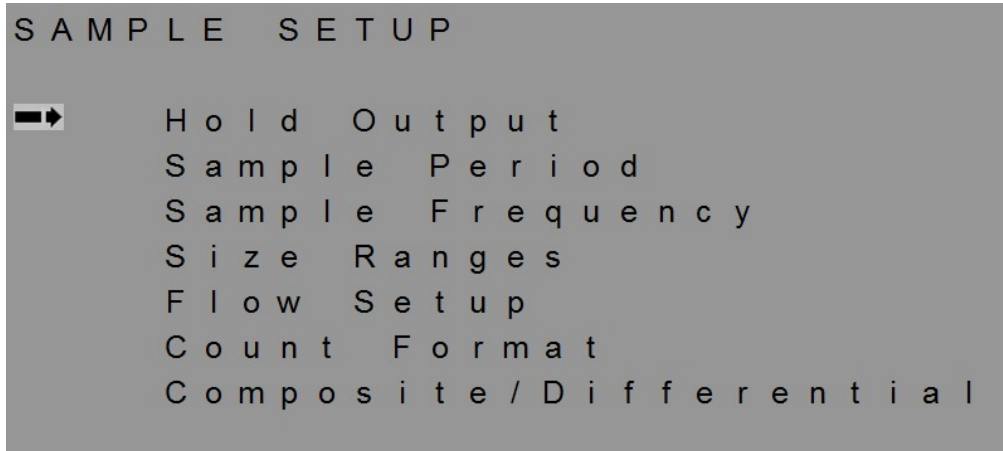

3.3.2.1 Hold Output

The Output Hold allows the user to temporarily hold the measurement result being sent to the analog outputs and digital communications (i.e., MODBUS) for a user defined length of time (up to 60 minutes). This function prevents data excursions to the SCADA/DCS while the unit is being serviced. The display on the PC3400 will display “Holding” in the bottom left-hand corner as long as the Output Hold is active. The PC3400 will still perform measurements and update the local display while Output Hold is active. A Hold can be initiated from outside the menu (while viewing the main display) by holding down the right arrow button for 3 seconds and then releasing (this feature only works on firmware 2.29 and higher). Hold time will be set to equal whatever is programmed into the user menu.

3.3.2.2 Sample Period

Sample Period is the number of seconds over which a measurement is made. Default value is 15 seconds. 30 to 60 seconds is recommended when using optional “ppb readout”. The range of the Sample Period is from 4 to 998 seconds.

3.3.2.3 Sample Frequency

Sample Frequency is the number of seconds between measurements. Default value is 60 seconds. The range of the Sample Frequency is from 5 to 999 seconds. The Sample Frequency must be greater than the Sample Period.

3.3.2.4 Size Ranges

The Size Ranges menu allows the user to establish the number of bins to be measured as well as the size ranges associated with those Bins. Up to 8 Bins can be established. The sizes used for each Bin must fall between 2 and 100 μm . When in Composite mode, the sizes need to be in sequence, smallest to largest and cannot overlap. The default size for each bin is shown below.

When entering the size settings, it is not necessary to use all 8 size Bins. Entering a value of 0 will turn the Bin(s) off. The default setting for Bin 7 and Bin 8 is 0, which is why there are only 6 Size Ranges

```
2 — 5    u m
5 — 1 0   u m
1 0 — 1 5  u m
1 5 — 2 5  u m
2 5 — 5 0  u m
5 0 — 1 0 0 u m
> 1 0 0   u m
```

active (not counting the 'greater than' range) when the unit is received from the factory.

3.3.2.5 Flow Setup

This menu allows the user to change the “**Fixed Rate**” flow value from the factory default setting of 75 ml/min to match the actual flow rate through the sensor (e.g., 70 ml/min) in order to achieve accurate count/ml or count/100ml readings. It is highly recommended to keep this setting at 75 ml/min and to adjust the actual flow rate to be 75 ml/min (as detailed in Section 2.4.4).

NOTE:

Particle sizing is most accurate when the flow rate through the sensor is within 10% of the flow rate at which the calibration was performed, which is typically 75 ml/min. Contact the factory if a special calibration is required at a different flow rate.

If the Particle Counter was ordered with the Optional flow meter, then the Flow Setup menu will have the option for selecting either “**Fixed Rate**” or “**Flow Meter**”. “Fixed Rate” is described in the above paragraph. To use the flow meter signal, the setting under Flow Setup needs to be set to “Flow Meter”. See section 3.6 for more information on Flow Meter setup.

NOTE:

If the flow meter was found to not be working reliably for any reason, it is recommended to turn off the Count Correction feature or to change the “Flow Setup” from Flow Meter to “Fixed Rate”

3.3.2.6 Composite or Differential

This menu will only appear if the user logs in with the Level 3 password (default password for Level 3 is 4321). **Composite / Differential** menu allows the user to choose between using Composite or Differential Size Range settings. Composite size ranges (like what is shown on previous page in section 3.3.2.2) cannot overlap. In Composite mode, if 5 micron is the “To” value in Bin 1 then it must also be the “From” value in Bin 2. In Differential mode, the bins can overlap. Below is an example of how the Differential Bins could be setup.

2	—	1 0 0	u m	—	7 3 7	/ m l
5	—	1 0 0	u m	—	8 2	/ m l
1 0	—	1 0 0	u m	—	3	/ m l
1 5	—	1 0 0	u m	—	1	/ m l
2 5	—	1 0 0	u m	—	0	/ m l
5 0	—	1 0 0	u m	—	0	/ m l

T i m e 1 6 : 2 0

3.3.2.7 Count Format

Allows user to choose between Counts per ml (default setting), Counts per 100 ml, and Raw Counts. If the optional volumetric parts per billion (ppb) feature is enabled, then additional selections including the ppb readout will be available.

3.3.3 General Setup (Analog Outputs, Communication Setup, Log Frequency, etc)

From the top Setup menu move the arrow down to “General Setup” and press **Enter**. You should see the below screen.

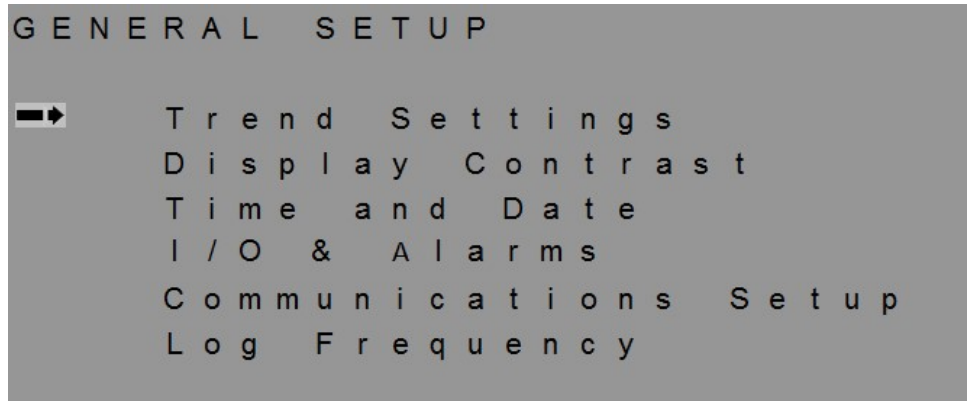

3.3.3.1 Trend Settings

The Trend Settings menu allows the user to map one of several variables to the Trend Graph. These include Total Counts, all Bin counts, Cell Condition, and Laser Condition. Upon selecting which variable to map to the graph, the menu prompts the user to select the max scaling for the graph. The range of the Trend Maximum scaling is from 1 to 65000. The default value is 200 counts.

3.3.3.2 Display Contrast

Allows the user to adjust the LCD contrast settings for best viewing performance.

3.3.3.3 Time and Date

Allows the user to set the time and date settings on the PC3400. Note: An internal battery keeps the internal clock running while the unit is turned off. The instrument will not automatically adjust for daylight savings time.

3.3.3.4 Analog Outputs & Alarms (Optional)

Under the I/O & Alarms menu the user can Map Alarm Relays and Map and Scale 4-20mA Outputs (Note: Relays and Analog Outputs are optional hardware and do not come standard on the Particle Counter).

The mapping options for the Alarm Relays and Outputs includes Total Counts, all Bin counts, Cell Condition, and Laser Condition. The user can map these parameters to any of the output channels they desire. After mapping the output, the user can then define the alarm threshold (for alarm relays) or the scaling (for 4-20 mA outputs). See section 2.3.4 for information related to wiring of analog outputs. See section 3.3.4.1.1 for information on calibrating the analog outputs.

The Alarm Setup allows the user to Map up to two Alarms and set the Alarm Threshold. The Alarm settings control the optional alarm relays if installed in Slot A. Alarm 1 controls Relay 1 and Alarm 2 controls Relay 2. Note: Relays installed in Slot B are used for the Sensor Flush option only.

3.3.3.5 *Communications Setup*

Under the Communications Setup menu the user can set the address of the PC3400, select Language options, choose the communication type (e.g. Standard Serial, RTU, TCP), set the Baud Rate, and enter the Network settings if the optional MODBUS TCP communications are being utilized.

Note: For Serial (RS232 & RS485) Communications, the default address is 1 and the range is from 1 to 255. Communication settings are by default 57600 baud, 8 Character Length, 1 stop bit, and Even for Parity.

Note: For Ethernet Communications, the default settings are as follows:

IP Address: 192.168.1.1

Gateway Address: 192.168.1.1

Subnet Mask: 255.255.255.0

IMPORTANT NOTES:

Depending on which "Communication Type" is selected under the Communication Setup menu, the "Status" screen (as shown in section 3.2.4) will display the serial / RTU communication settings (e.g. Baud Rate) or the IP Address.

For optimum communications reliability, the recommended poll frequency for the PC3400 is 0.5 seconds max.

The instrument will not communicate when a menu screen is active. Communications will resume when the menu is exited.

3.3.3.6 *Log Frequency*

This menu allows the user to selecting how often the data log and graph are updated with new data. Log Frequency is in minutes and the range is from 0 to 255 minutes. The default Log Frequency is 0 minutes. With the setting of 0 minutes, the data log and graph will be updated with each measurement taken.

3.3.4 Service Setup (Calibration, Log Erase, Analog Output Calibration)

From the top Setup menu move the arrow down to “Service Setup” and press **Enter**. You should see the below screen.

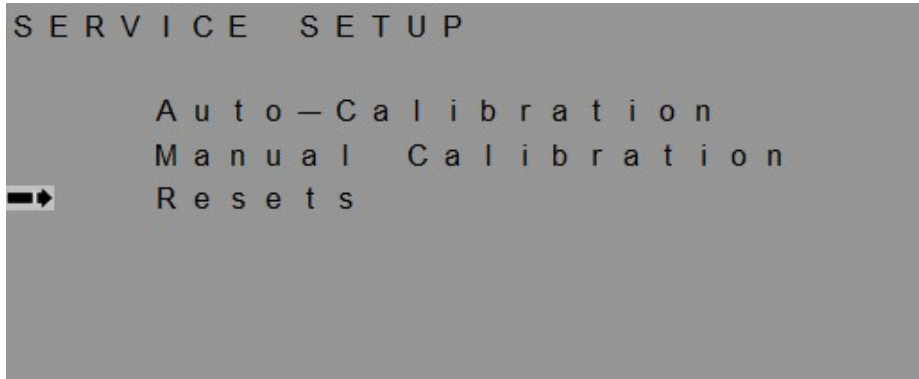

3.3.4.1 Auto-Calibration & Manual Calibration

The settings under this menu are used to adjust the calibration of the PC3400. These menus should not be accessed unless the person accessing the menu has thoroughly reviewed the calibration procedure provided by Chemtrac, Inc. The calibration procedure is a separate document from this manual and can be obtained by contacting Chemtrac at 770-449-6233 or via email at Chemtrac@chemtrac.com. Please provide your full contact info as well as your instrument's version and serial number.

3.3.4.1.1 4-20mA Output Calibration

If the PC3400 is equipped with an optional 4-20mA Output Board, the 4-20 mA outputs can be set to 4mA or 20mA by accessing the **Output Adjust** menu under the **Manual Calibration** option (located under Menu > Service Setup > Manual Calibration > Output Adjust). Select the installation slot (A or B) where the outputs are installed, then select the output number. Connect a milliamp meter to the appropriate output terminals and select 4mA from the menu (see section 2.3.4 for information on analog output wiring terminals). Adjust the digital values as necessary to achieve an output of 4.00 mA. When complete, press the 'Menu' button and select 20mA. Adjust the digital values as necessary to achieve an output of 20.0 mA. Several options exist for analog I/O on the PC3400. The following image shows a 4 output board installed in Slot A.

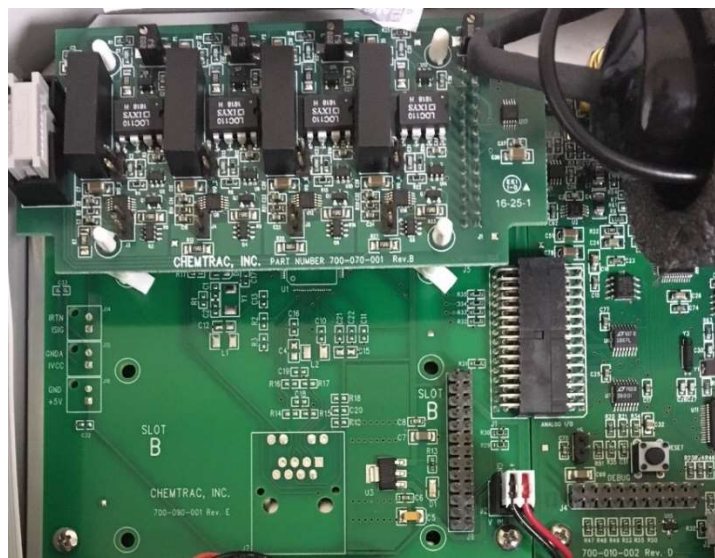

Figure 16 Optional Analog Output Board Installed in Slot A

3.3.4.2 Resets

Under the Resets menu there are three selections.

Restore Factory Cal – This will take all the instrument settings, including the calibration settings, back to what they were when the unit shipped from the factory. This is provided to allow the user to return back to factory settings in the event the unit is no longer operating properly, and it is suspected that changes to critical instrument settings may have been made that are affecting the unit's operation.

Tech User Login – Enabling the Tech User Login will limit normal users to only being able to do two things:

1. Enable the "Output Hold" so they can service the sensor without disrupting the data being sent to the SCADA/DCS.
2. Change the scaling for the Trend on the front panel display.

When enabling the Tech User Login, the user will be required to enter the old password. On a new unit the password is **1234**. Once the correct "old" password has been entered, the user is allowed to Enable the Tech User Login and create a new password. Be sure to record this password in a secure location. If the password is lost, contact Chemtrac for a password reset.

Erase Data Memory – This will clear the PC3400's data log. Once data is erased, it cannot be retrieved. If you wish to retain the logged data, be sure to download the log using the TracData download software prior to erasing.

Note: It does require Level 2 Tech User access to erase memory. It is recommended to enable Tech User Login in order to prevent unauthorized erasing of the data log

3.4 RS-485/RS-232 COMMUNICATION AND POWER INDICATORS

The PC3400 comes equipped with three status LED's. One red LED to indicate power and a yellow LED for TX and a green LED for RX to indicate the unit is properly communicating with the host computer. The red power LED in combination with the illuminated LCD lets the user know the unit has the appropriate power to function properly. **Note:** The yellow TX LED will blink once on power up.

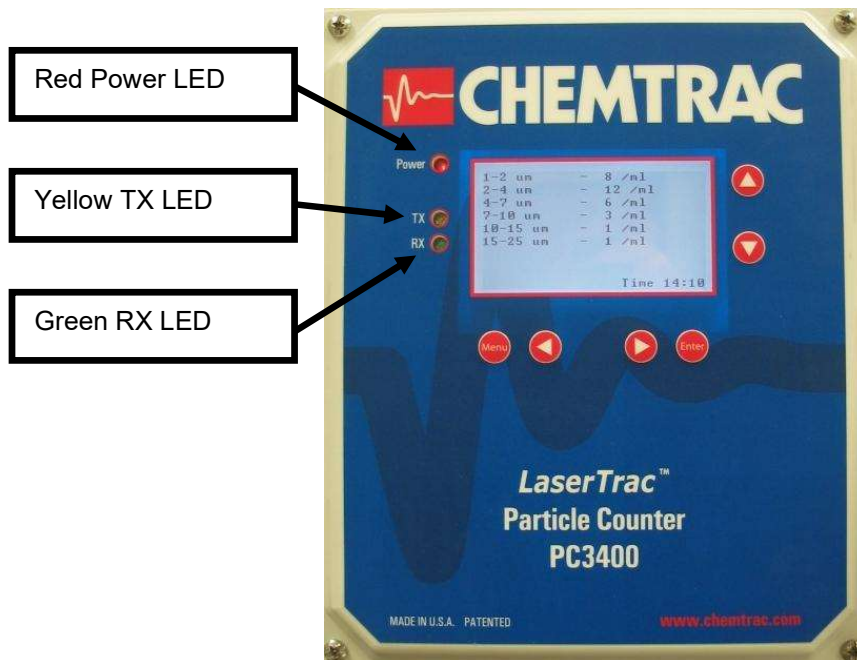

Status LEDs

3.5 ROUTINE MAINTENANCE

It is important that a consistent flow rate be maintained since the data produced by the particle counter is based on the sample volume (particles per milliliter). As the tubing and flow cell become dirty, flow will be restricted. Therefore, it is necessary that a proper maintenance schedule be followed to ensure the flow rate is not adversely impacted from fouling.

If adequate sample pressure is available, the constant head flow control weir will maintain an accurate flow rate through the sensor. Flow problems will only be caused by fouling of the flow cell and fouling of the tubing and barb fittings. Obviously, the more turbid the sample, the more likely clogging / fouling will occur. If raw water is being sampled, it is recommended that a small 40 mesh strainer be placed in line before the sensor to catch debris.

Routine cleaning of the flow cell should be performed on a regular basis. How often the flow cell should be cleaned will vary depending on water quality. The cell condition is monitored by the particle counter electronics and can be used as an indication of when cleaning is necessary. A drop in the cell condition to 85% (or 10 to 15% from previous reading obtained after cleaning) indicates that cleaning should be performed.

Any standard laboratory cleaner can be used to clean the flow cell. If iron or manganese buildup is a problem, vinegar, CLR, or another slightly acidic liquid, can be used. The cleaner can be flushed through the flow cell or applied using the cleaning brush. The sapphire window material and the external flow cell design make brush cleaning a safe and effective method for removing tough contaminants.

NOTE

Prior to connecting the sensor, the sample line should be flushed thoroughly. Failure to do this is a common cause of clogged sensors.

Several methods may be used to clear a clogged flow cell. One of the most effective tools is a small can of compressed air (available at most hardware stores). Remove the tubing from both sides of the flow cell and blow the air through the flow cell from the top of the flow cell (opposite direction from the flow). If compressed air is not available run the liquid sample in from the top of the flow cell and increase the flow rate. The flow cell windows are sapphire, which is scratch resistant, but it is not recommended that pieces of wire or other objects be used to clear clogs. Once the clog is removed, a light can be shined through the sensor to allow visual inspection. The flow cell opening is large enough to see through when clear.

NOTE

The particle counter can still count particles with a dirty flow cell, but the accuracy may be diminished.

3.5.1 Non-brush Cleaning

Fill a large syringe with cleaner (diluted to manufacturer's recommendation) and attach it to the top flow cell barb with a short piece of tubing (See Figure 17). Squeeze the syringe to introduce the cleaner into the sensor and let it sit for a few minutes and then inject some more and let that stand a few more minutes. Finally, force the remaining cleaner rapidly through the flow cell. The rapid flow should remove most buildup that has occurred in the sensor and bring the cell condition back up to an acceptable level. Non-brush cleaning is not a replacement for occasionally cleaning with a brush, but it useful when you don't have a brush on hand.

3.5.2 Brush Cleaning

Remove the tubing from the sensor's fittings. Insert brush from top of sensor until it rests snugly in the flow cell (See Figure 19). Move the brush in and out of the flow cell using short strokes. Brush again from the other side of the sensor.



Figure 17 Sensor Cleaning Methods

NOTE

The small size of the brush makes it easy to bend or damage. Do not force the brush into the flow cell. It should fit into the flow cell with light pressure.

Once cleaning has been performed, reattach flow lines and allow a minute or so for the flow cell to flush out. Verify that the cell condition indicator is back in the 90% range. If it is not, repeat the procedure.

NOTE

The cell condition indicator is not valid if the sensor is not full of water and clear of air bubbles.

3.5.3 Replacing Tubing

As the tubing becomes dirty, it will restrict flow through the sensor and can also contribute to higher counts (especially if the tubing is disturbed), so sensor tubing should be replaced as it becomes visibly fouled. It is not necessary to replace the Flow Control Weir drain tubing or the drain tubing on the bottom of the Drain Cup. Weir Inlet tubing should be replaced on occasion to help reduce the potential for vibration or any kind of movement on the tubing to release particles. Ensure that sample flow has been stopped, any pressure build up has dissipated and liquid has drained prior to disconnecting any tubing. It is reasonable to expect some liquid spillage when disconnecting tubing so be certain that no sensitive electronics or live circuits are exposed.

3.5.4 Replacing Desiccants

Desiccant pouches are inside the enclosure and inside the sensor cap. The desiccant inside the enclosure should be replaced annually to prevent condensation from developing on the sensor optics. The desiccant inside the sensor cap will rarely have to be replaced unless the cap has been removed for service.

NOTE

If condensation forms on the sensor optics, you will likely see a significant drop in the Cell % that does not improve with cleaning.

3.5.5 Battery Replacement

In the event of a loss of power, the PC3400 utilizes a battery backup for the sole purpose of maintaining the real time clock. Under normal operation, the battery should last several years before requiring replacement. The recommended battery is a lithium coin, 3 volts, 23mm, CR2330. When replacing the battery, be certain to install the battery with the proper polarity. The positive side of the battery should be facing left when inserted. See figure 18.

Positive side of battery to left.



Figure 18 Battery Installation

3.6 Optional Flow Meter

An optional Flow Meter is available to measure the sample flow rate through the particle counter sensor. The flow reading can be used to alarm on low flow and correct both sizing and counting accuracy in the event flow was to change. Note: The count correction feature is disabled by default and must be enabled by the end user after the flow meter has been calibrated. Two types of flow meter are available for the PC3400 and are referred to as “Tipper Flow Meter” and “Magnetic Inductive Flow Meter”.

The **Tipper Flow Meter** is a more economical device capable of maintaining 10% accuracy with monthly calibration. This flow meter recommended for applications where customer requires alarm for low flow or loss of flow. This device uses a tipping bucket to determine flow rate. As water enters the flow meter, one side of the bucket fills and then tips when full, allowing the other side to fill and then tip the other way. A sensor detects the frequency at which the device tips and this is used to calculate the flow. The flow meter enclosure is vented to allow air flow which helps to prevent condensation from forming on internal surfaces which can otherwise impact flow measurement accuracy. See section 3.6.1 for more information.

The **Magnetic Inductive Flow Meter** provides a more accurate and stable measurement of flow. It also has the advantage of no moving parts. This type of flow meter works by directing the flow of conductive fluid through a magnetic field which produces a voltage proportional to flow. The Magnetic Inductive flow meter is recommended for applications where sizing and counting accuracy need to be maintained to the greatest extent possible when changes in sample flow occur.

When either flow meter is utilized, the averaged flow reading is displayed on the PC3400 at the bottom of the results screen, and the non-averaged (real-time) flow reading is displayed on the Status screen. The averaged flow reading takes around 1 minute to fully stabilize. Note: The flow reading is only displayed when the particle counter is not sampling. See section 3.6.2 for more information.

3.6.1 Tipper Flow Meter Installation

The optional flow meter mounts directly to the Weir as shown in figure 19. Position the flow meter so the top of the enclosure is approximately 20 inches down from the overflow sight glass. Connect the flow meter wiring to the I/O Base Board as shown below. Red wire goes to +5V, the Black wire goes to GND, and the White wire goes to INP. A Green LED in the bottom left portion of the I/O Base Board will briefly flash each time the bucket tips.

Start flow through the weir, ensuring water is overflowing through sight glass. Verify water is passing into the flow meter and that the bucket inside flow meter is tipping around every 3 seconds. The Green LED located on the flow meter input board will briefly flash each time the bucket tips. If the Green LED is not seen to be flashing but the bucket is tipping, verify the tipper is wired correctly and then contact factory for assistance. See section 3.6.4 for instructions on calibrating the flow meter reading. It is recommended to recalibrate the flow meter after a few days as the tipping frequency does tend to change in the first 48 hours, and then recheck calibration once per month in order to maintain better than 10% flow measurement accuracy.

The flow meter will require periodic cleaning to maintain proper operation. The lid of the flowmeter is removed by unscrewing the 4 corner screws. With the lid removed, the tipper bucket can be accessed for cleaning to remove any deposits or buildup. Ensure tipper bucket can move freely from side to side.

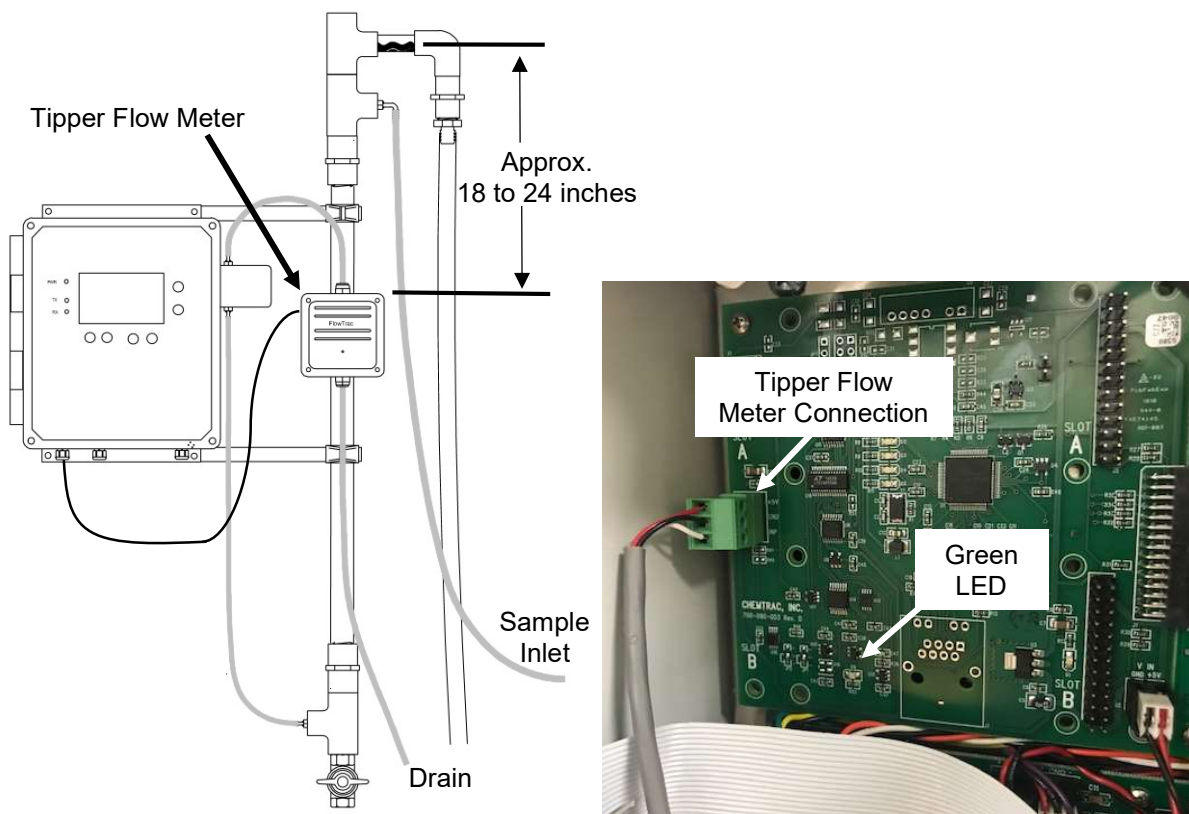

Figure 19 Tipper Flow Meter Installation & Wiring

3.6.2 Magnetic Inductive Flow Meter Installation

The optional flow meter mounts directly to the Weir as shown in figure 20. Connect the flow meter wiring to the I/O Base Board as shown below. White wire goes to second position from top, the Blue wire goes to third position, and the Brown wire goes to bottom position.

Start flow through the weir, ensuring water is overflowing through sight glass. Verify water is passing through the flow meter, sensor, and into the drain cup. See section 3.6.4 for instructions on calibrating the flow meter reading. Recheck calibration once every 6 months to maintain better than 5% flow measurement accuracy.

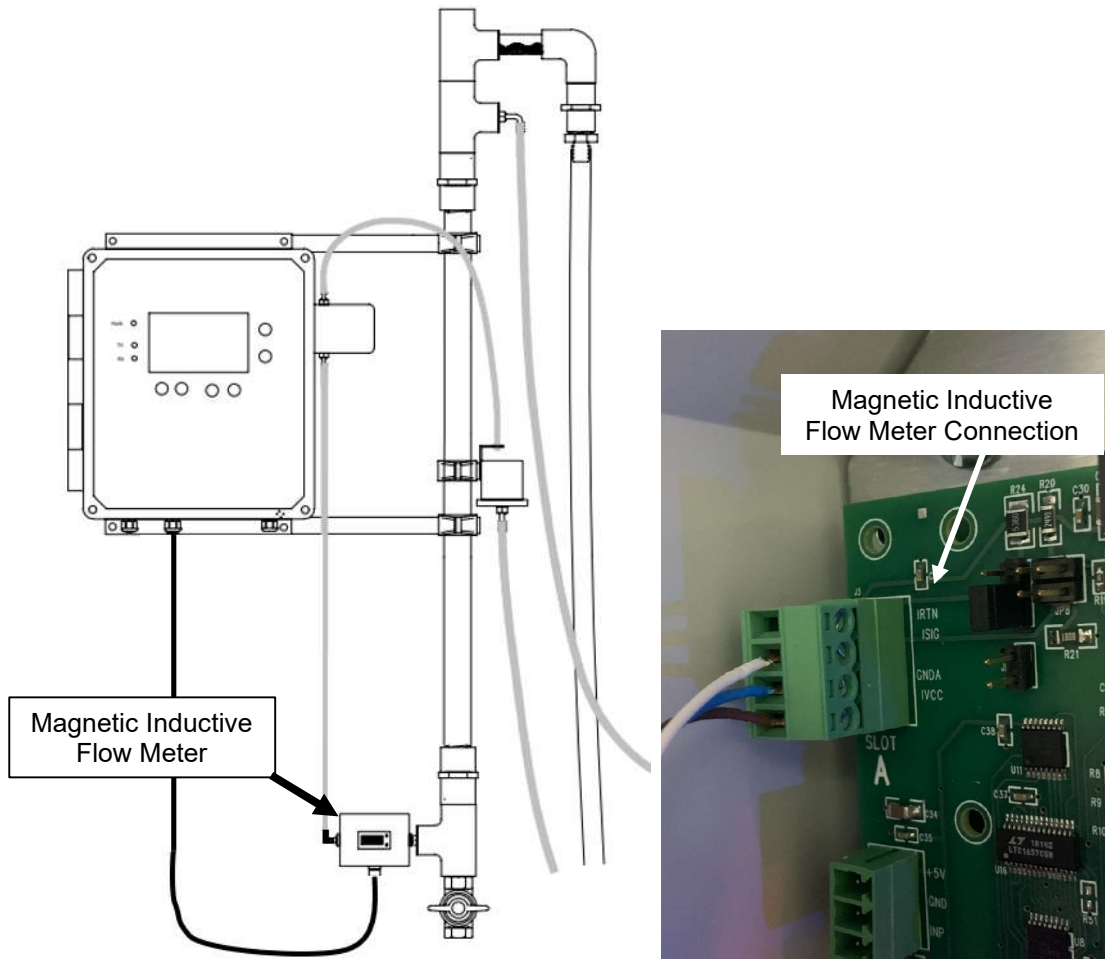

Figure 20 Magnetic Inductive Flow Meter Installation & Wiring

3.6.2.1 Flow Meter Setup

The flow meter comes from factory already programmed and user does not need to change any settings on the flow meter. Below instructions provided for reference only.

Set Output 2 on flowmeter to be 0-10 VDC.

1. Press Mode/Enter until display shows "ou2".
2. Hold the Set button down for approximately 6 seconds. The display will flash for the first 5 seconds and then stop flashing, at which point you want to release the Set button.
3. Press the Set button until the display shows "U" (this comes directly after "I"). The "U" changes Output 2 to a 0-10 VDC output.
4. Press the Mode/Enter button to save the change. The display will return to showing "ou2".
5. Proceed to next procedure, or press the Mode/Enter button repeatedly to exit the menu, or do nothing

and the flowmeter will exit menu on its own in 30 seconds.

Set Output 2 scaling to be 0 to 600 ml/min.

Note: the lowest scaling allowed on the IFM is 600 ml/min.

1. Press the Mode/Enter button until display shows "AEP2".
2. Hold the Set button down for approximately 6 seconds. The display will flash for the first 5 seconds and then stop flashing, at which point you want to release the Set button.
3. Press the Set button until the displays shows "600". Note: if the display is showing "3000", you only need to press the Set button one time and that rolls the display over to "600". If you go past 600, then hold the Set button down and this will cause the display value to change quickly and climb back up to 3000 and then you can release the Set button and then press the Set button until display shows "600".
4. Press the Mode/Enter button to save the change. The display will return to showing "AEP2".
5. Proceed to next procedure, or press the Mode/Enter button repeatedly to exit the menu, or do nothing and the flowmeter will exit menu on its own in 30 seconds.

Set flowmeter averaging to 5 seconds.

Note: 5 seconds is the maximum averaging time allowed.

1. Press the Mode/Enter button until display shows "EF" and then press the Set button.
2. Display should now show "Hi.F".
3. Press the Mode/Enter button until displays shows "dAP".
4. Hold the Set button down for approximately 6 seconds. The display will flash for the first 5 seconds and then stop flashing, at which point you want to release the Set button.
5. Press the Set button until the display shows "5.0".
6. Press the Mode/Enter button to save the change. The display will return to showing "dAP".
7. Proceed to next procedure, or press the Mode/Enter button repeatedly to exit the menu, or do nothing and the flowmeter will exit menu on its own in 30 seconds.

Change the direction of flow

Note: The factory default direction of flow is left to right (when facing display in right side up position). This needs to be changed so direction of flow is right to left.

1. Press the Mode/Enter button until display shows "EF" and then press the Set button.
2. Display should now show "Hi.F".
3. Press the Mode/Enter button until displays shows "Fdir".
4. Hold the Set button down for approximately 6 seconds. The display will flash for the first 5 seconds and then stop flashing, at which point you want to release the Set button.
5. Press the Set button until the display shows "-". (changing to "-" means flow will be going right to left as facing display).
6. Press the Mode/Enter button to save the change. The display will return to showing "Fdir".
7. Proceed to next procedure, or press the Mode/Enter button repeatedly to exit the menu, or do nothing and the flowmeter will exit menu on its own in 30 seconds

3.6.3 Enabling / Disabling Flow Meter & Count Correction Feature

Below are instructions for enabling the flow meter:

1. Press Menu and then go to Sample Setup> Flow Setup
2. Select "Flow Meter" and then press Enter
3. Set Target Flow Rate for "75" and then press Enter
4. Select "Yes" to enable Count Correction feature. Select "No" to disable the Count Correction feature.
5. Press the Menu button repeatedly to exit the menu.

Note: It is not recommended to enable the Count Correction feature until after the flow meter has been calibrated. Calibrate flow meter in accordance with section 3.6.4.

Below are instructions for disabling the flow meter:

1. Press Menu and then go to Sample Setup> Flow Setup
2. Select "Fixed Flow" and then press Enter
3. Set Flow Rate for "75" and then press Enter.
4. Press the Menu button repeatedly to exit the menu.

3.6.4 Flow Meter Calibration

The flow meter reading on the PC3400 display must be calibrated in order to read accurately. It is recommended to run water through the flow meter for 24 hours prior to doing the initial calibration.

3.6.4.1 Tipper Flow Meter Calibration

The Tipper flow meter calibration requires first unhooking the tubing from the top of the flow meter so that the flow to the device can be measured. It is very important to position the end of the tubing so that it is even with the top of the flow meter enclosure as shown in image to right. If the tubing is held higher or lower than this position, then the flow rate measured will not be representative of the flow obtained when the tubing is connected to the top of the flow meter device. Once the tubing is positioned correctly, the water exiting the tubing is collected in a 100 ml graduated cylinder for 60 seconds. It is very important to hold the tubing steady and to keep the end of the tubing aligned with the top of the enclosure while measuring the flow.

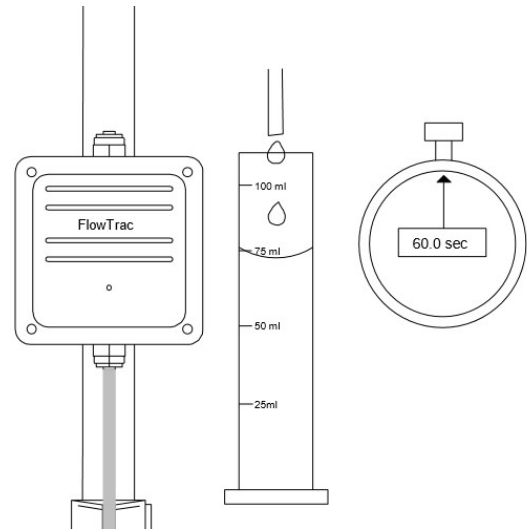

If the flow rate is not within +/-3 mL of 75 ml/min, simply reposition the flow meter and then re-measure the flow.

Lower the flow meter enclosure to increase the flow rate if the measured flow is <72 ml/min, or raise the enclosure if the measured flow is >78 ml/min. Once the flow rate is set to between 72 to 78 ml/min, the flow meter calibration can be performed. Calibration is performed by holding down the left arrow button for 3 seconds and then following the onscreen prompts. Once per month calibration is recommended to ensure flow measurement accuracy is better than 10%.

3.6.4.2 Magnetic Inductive Flow Meter Calibration

The Magnetic Inductive flow meter calibration requires first unhooking the tubing from the drain cup so that the flow can be measured. It is very important to hold the end of the tubing at the same vertical position that the tubing resides at when inserted into the drain cup (as shown in image to right). If the tubing is held higher or lower than this position, then the flow rate measured will not be representative of the flow obtained when the tubing is inserted into the drain cup. Once the tubing is positioned correctly, the water exiting the tubing is collected in a 100 ml graduated cylinder for 60 seconds. It is very important to hold the tubing steady and to keep the end of the tubing aligned with the top of the enclosure while measuring the flow.

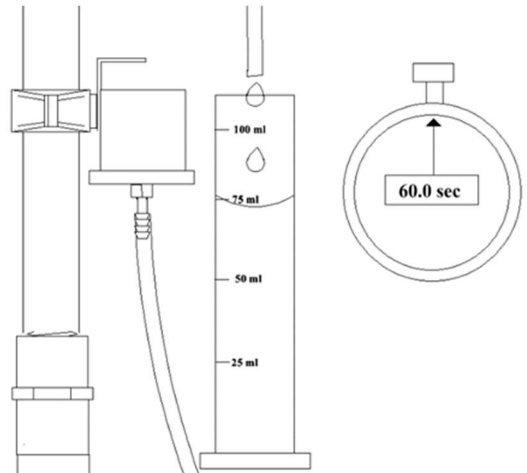

If the flow rate is not within +/-3 mL of 75 ml/min, simply reposition the drain cup and then re-measure the flow. Lower

the drain cup to increase the flow rate if the measured flow is <72 ml/min, or raise the enclosure if the measured flow is >78 ml/min. Once the flow rate is set to between 72 to 78 ml/min, the calibration of the PC3400's flow meter reading can be performed. Calibration is performed by holding down the left arrow button for 3 seconds and then following the onscreen prompts. Calibration is recommended every 6 months to ensure flow measurement accuracy is better than 5%.

Note: For more accurate counting and sizing results, the "Count Correction" feature can be enabled (see section 3.6.1.1). Flow should be maintained between 50 to 90 mL/minute (75 mL/minute is optimum).

3.7 Automatic Sensor Flush Option

An optional sensor flush feature is available for applications where frequent cleaning of the sensor would otherwise be required. Such applications include monitoring of inlet raw water or settled water in a drinking water treatment plant. The automatic sensor flush option consists of two 110 VAC (or 220 VAC) solenoid valves. A 3-way valve is used to backflush the sensor with clean, potable quality water (30 to 80 psi), while a second valve is used to drain the weir assembly. Both valves are controlled by a relay inside the PC3400 (the relay is installed in Slot B of the I/O Expansion Card). The frequency and duration of the flush, as well as the hold time, is controlled by user settings in the menu. To enable the automatic flushing and access the settings, go to Menu > General Setup > Auto Clean Enable

The below diagram shows the location, plumbing, and wiring of the flush valves.

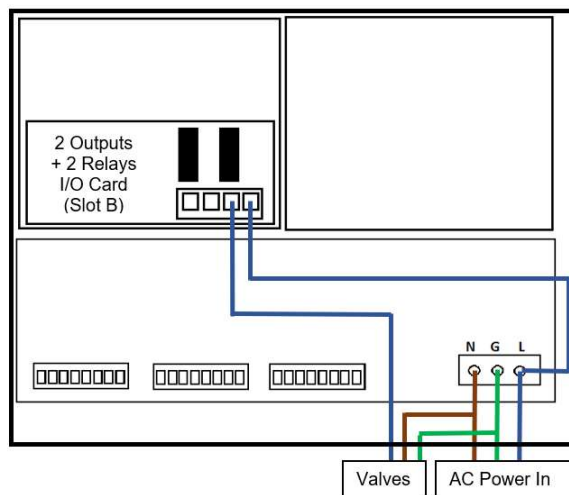
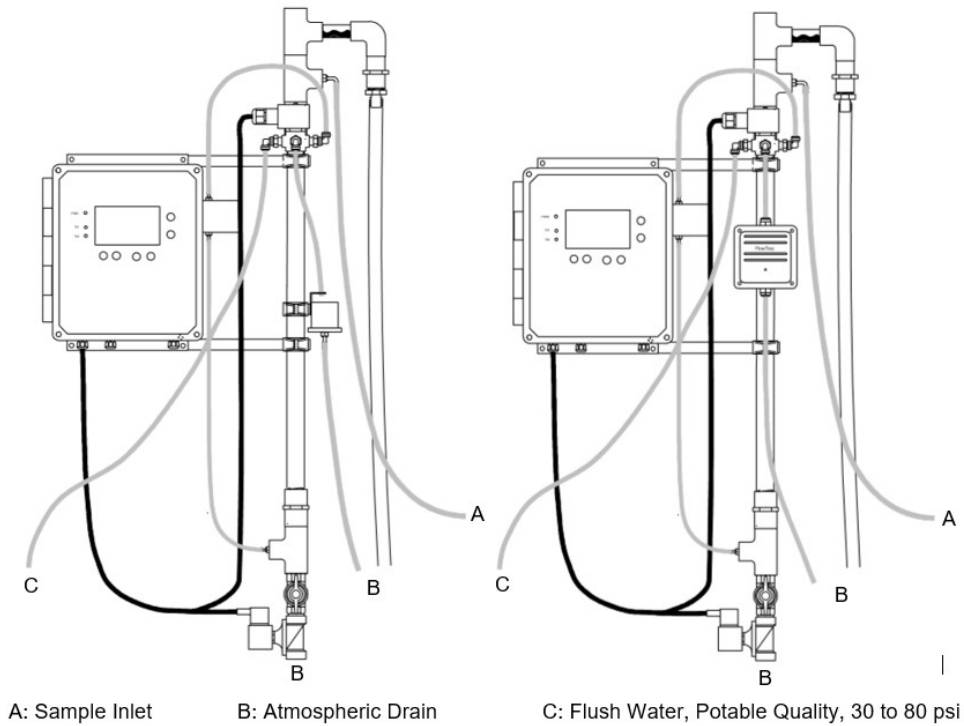

Figure 21 Automatic Sensor Flush Plumbing & Wiring

4.0 DOWNLOADING DATA

The PC3400 records all measurement data in internal flash memory. The internal memory holds over 65,000 sample strings of data. This data can be downloaded over an RS-232 or USB connection using the TracData software.

4.1 INSTALLING AND SETTING UP TRACDATA SOFTWARE

The TracData software can be downloaded from the Download page at www.chemtrac.com. There are two versions of TracData. One version is for Particle Counters with firmware version <2.0 and the other is for units with firmware version >2.0. To check the version of firmware that is installed, press the down arrow on the PC3400 display two times to access the Status screen shown below. The Firmware Version is shown in the upper right hand corner. In this example, the firmware version is >2.0.

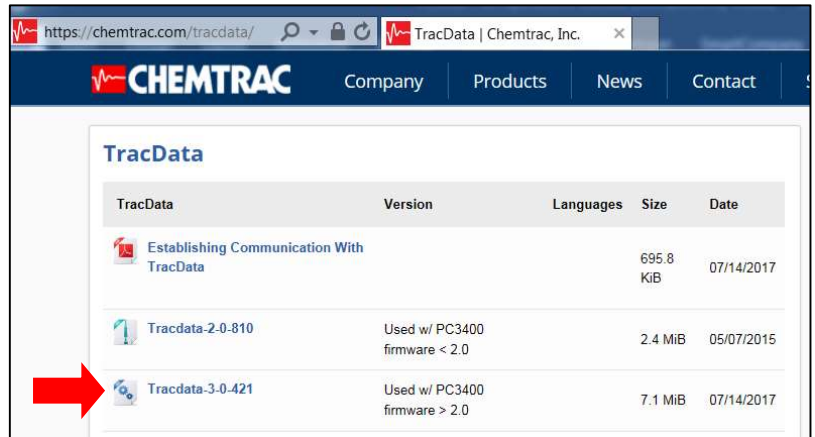
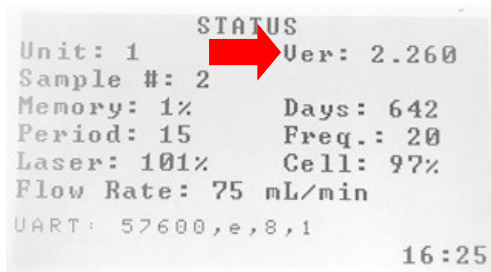

Download and install the executable. If the message shown below is displayed, click on Run. Follow the instructions provided by the InstallShield Wizard and be sure to note where the TracData software data gets installed. The default location is C:\Program Files\Chemtrac\TracData



Open TracData by clicking the newly created icon on the desktop.



4.2 CONNECTING DOWNLOAD CABLE

4.2.1 Option 1 - Standard A/B USB Cable

The recommended method for downloading the data is to use a standard A/B USB cable. An image of the USB cable and where it is connected on the PC3400 is shown below.

Note: Older versions of the PC3400 may not have the USB port. Those will require an RS-232 cable to download data (see Option 2 below).

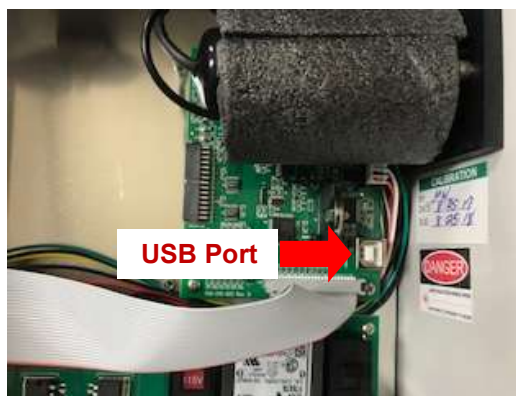

A specific windows USB driver is required in order to connect the computer to the PC3400. The USB driver will automatically load if the computer has internet access when it is being connected to the PC3400 (make sure the TracData software is closed). If the computer does not have internet access or fails to load the driver, email support@chemtrac.com for a instruction on how to manually load the driver.

Make sure the PC3400 is turned off and then plug the USB cable into the computer and the PC3400. Next, turn on the PC3400 and allow the computer a minute to recognize the USB device and load in the driver (the driver install only occurs the first time you connect, providing the computer can access the internet).

When the message “Your device is now ready to use”, proceed to opening the TracData software and proceed to section 4.3 (page 47) of this manual.

If more than one comm port is being found by the TracData software, go to Edit>Open Device Manager in TracData. This will open Windows Device Manager (shown below). Use this to identify the USB port that is being used to communicate with the PC3400. Under the Device Manger, find and expand the Ports (COM & LPT) section. Find the COM Port for the device that will be used in this configuration. In most cases it will be labeled USB Serial Port, followed by a COM #. See the image below for an example. If there is more than one, identify the correct port by unhooking the cable from the PC3400 to see which COM Port disappears and then plug the cable back in.

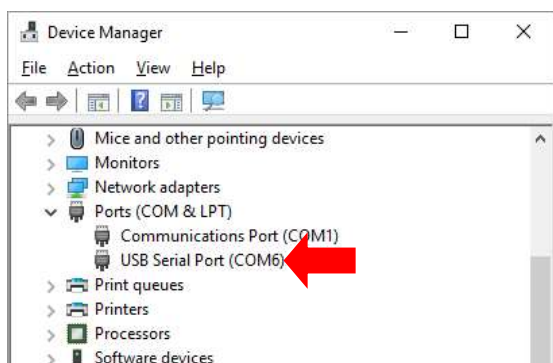

4.2.2 Option 2 – RS-232 Download Cable

Skip this section if using USB cable to download data. This option is only recommended if the PC3400 does not have a USB Port. Contact Chemtrac at 770-449-6233 or chemtrac@chemtrac.com if the optional RS-232 download cable is required.



Connect the DB9 end of the download cable to a Com port on your PC. Alternatively, if your computer only has USB ports, you will need to connect the DB9 connector to a USB to Serial converter that gets plugged into a USB port. Contact Chemtrac for recommended USB to Serial converters.

Connect the other end of the download cable, which is the 8 position green terminal, to the PC3400's RS-232 Communications connector shown below.

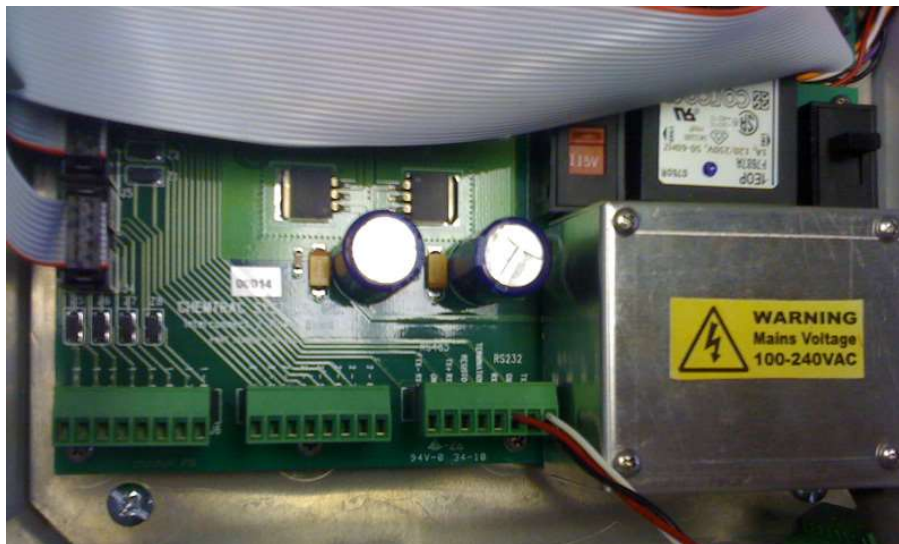

Press the Menu button on the PC3400's front panel display. If the Login is enabled for Level 2 Tech User access, you will need to first enter the login code. Then go to the following menu:

4.3 VERIFYING COMMUNICATION SETTINGS

If all the instructions in the previous section have been followed, the user is now ready to download the data.

Open the TracData software and review the serial port settings by clicking on the **Gear**  icon or by clicking on **Edit** and then click on **Modbus Device Port Settings**. The below screen will appear.

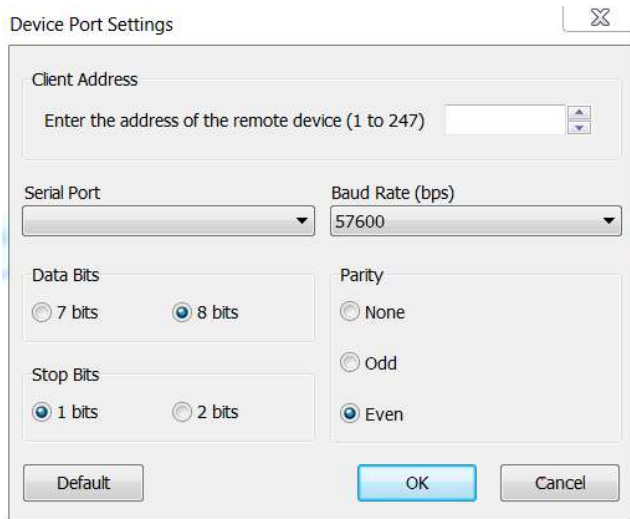

For **COM Port**, use whatever COM port number appears. If more than one COM Port appears, then use the port number that was identified under the Device Menu (see section 4.2.1). For the **Client Address**, enter the Unit Address found on the Status screen (see below image).

Ensure the settings for Baud Rate, Data Bits, Stop Bits, and Parity are the same as shown above. For TracData to be able to communicate, the PC3400 must use the exact same settings. Follow the below instructions to verify the PC3400 is programmed to use the same communication settings.

- 1) If currently in the Menu, press the **Menu** button to exit.
- 2) Press the down arrow button (located to the right of the display) until the **Status** screen is reached.
- 3) Ensure the PC3400's Baud Rate, Data Bits, Stop Bits, and Parity settings match those shown in below image. If the settings do not match or do not appear, then follow the instructions provided on the next page to change the settings.

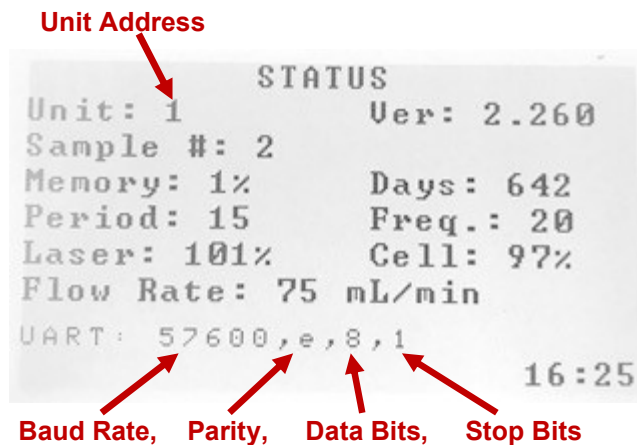

Note: Parity setting will display as “e” for even, “o” for odd, and “n” for none.

Configure Baud Rate

- 1) Press the **Menu** button and select **General Setup > Communications Setup**.
- 2) Select **Baud Rate** from the menu.
- 3) Use the arrow keys to select **57600** as the Baud Rate and press **Enter**.
- 4) Continue by selecting the Character Length (Data Bits), Stop Bits, and Parity and making sure those are set for **8**, **1**, and **Even** respectively. Press **Enter** after each selection.

Configure Communication Type

- 1) From the Communications Setup menu, scroll down and select **Communication Type**.
- 2) Scroll to select the **Modbus RTU** option. Press the **Enter** button.
- 3) Press the **Menu** button 3 times to exit the menu.

4.4 INSTRUCTIONS FOR DOWNLOADING AND EXPORTING DATA

- 1) Ensure the PC3400 display is not in the User Menu, then click the Connect  icon, or click on **Edit** and then **Connect**. **Note:** Do not enter the User Menu on the PC3400 during the download process as this will abort the download and may result in having to reinitialize the software and COM port.
- 2) Select **# of Recent Records** option and enter the # of records to download in the field provided. It is recommended to initially use a small number (e.g. 10) on your first attempt to test communication. **Note:** It can take up to 5 minutes to download 1000 records. If it is not necessary to download every record, the **Data Retrieval Interval** setting can be used to skip a specified number of records and help speed up downloading time.

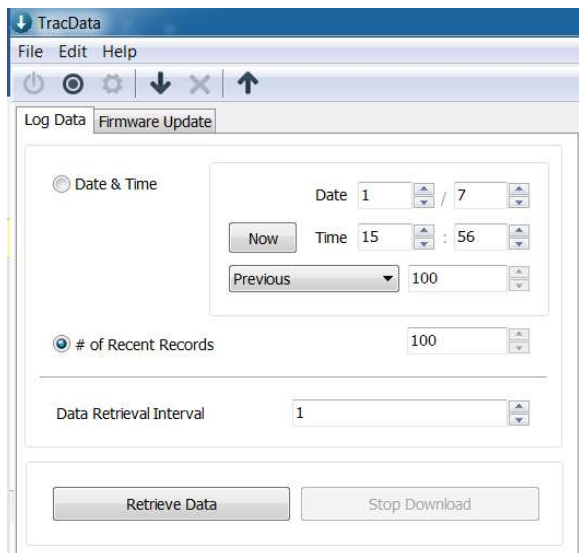

NOTE: Selecting **Date & Time** option will only work if a date and time is entered that exactly matches a record that is stored in the Particle Counter.

- Before starting the download, look to see if the word **Sampling** appears on the display. If it does, wait for that to disappear and then press the **Retrieve Data** button in TracData software to start the download process. If the PC3400 goes into “Sampling” right before the download starts, the download will abort and another attempt will need to be made.

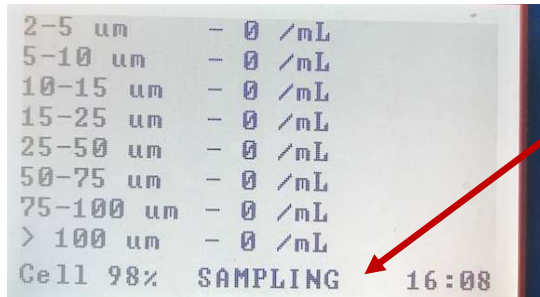

TracData will not be able to download the data when the display is showing “Sampling”. Wait for “Sampling” message to disappear before clicking on “Retrieve Data” in the TracData software.

Note: Make sure the PC3400 display is not in the User Menu. TracData cannot communicate to the PC3400 if it is in the User Menu mode.

The image below shows what the TracData software will look like after data has been retrieved from the Particle Counter. Once a download has been completed, the user can see the “Current Record” number which indicates how many records are currently stored in memory.

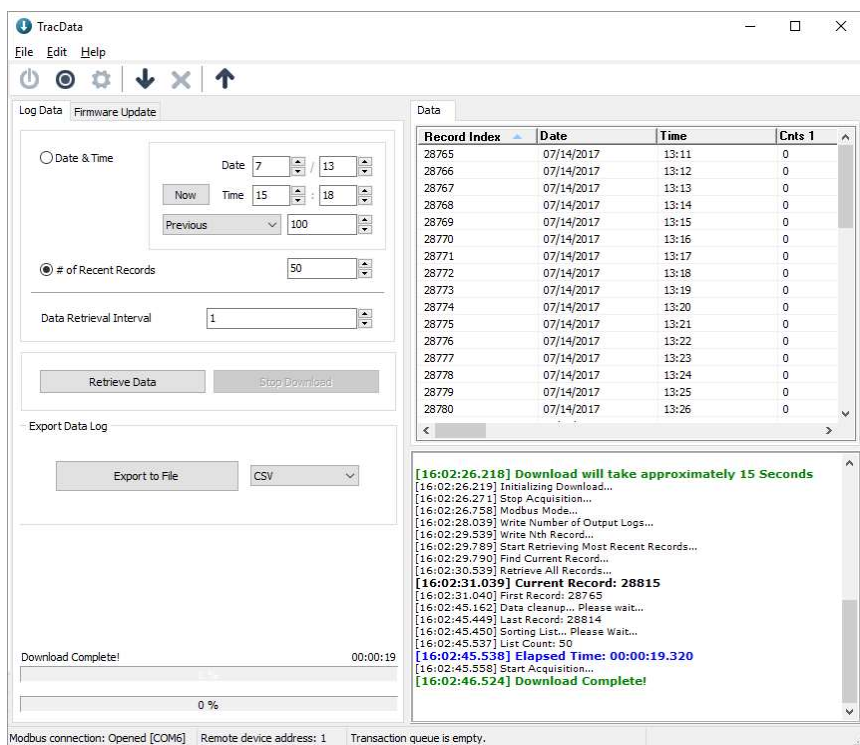

4.4.1 Exporting Data

The data is now ready for export. It is recommended to export the data as HTML as this will also export the column headings. Exporting as XLS or CSV will only export the data and not the column headings. Once the data has been downloaded and exported as an HTML, XLS, or CSV file; it can be opened and viewed using a spreadsheet program like Microsoft Excel software.

4.4.2 Erasing Logged Data

Once it has been verified that the data has been downloaded and been exported to the desired file type, the PC3400's memory can be erased by going to **Menu>Service Setup>Resets>Erase Data Memory**. Once the erasing process begins it can take up to 5 minutes to complete. While the data is being erased, the PC3400 will appear non-responsive. Once the data is erased, the PC3400 will begin normal operation.

Note: It does require Level 2 Tech User access to erase memory. It is recommended to enable Tech User Login in order to prevent unauthorized erasing of the data log (see section 5.3.4.2 of this manual for more info).

5.0 RECOMMENDED SPARE PARTS LIST

<u>Part #</u>	<u>Description</u>
11420	Sensor Sample Tubing*
11425	Weir Inlet & Drain Cup Tubing*
34400	Sensor Cleaning Brush

*Tubing can also be ordered from Cole Parmer using the below product numbers:

PN: 06509-16 (Sensor Sample Tubing)

PN: 06509-15 (Weir Inlet and Drain Cup Tubing)

5.1 ORDERING SPARE PARTS

To place an order for spare parts you may either call, e-mail, or fax Chemtrac Inc. directly or contact your local distributor or representative. The following information should be included in your request; model number and serial number of Particle Counter, part number(s), qty, and description of parts needed. Pricing and availability are available upon request.

Normal lead-time in stock parts is 1 to 2 days.

Chemtrac Inc.
1555 Oakbrook Dr, Suite 100
Norcross GA 30093

Ph: Inside US 1-800-442-8722, 770-449-6233

Fax: 770-447-0889

Email: chemtrac@chemtrac.com

www.chemtrac.com

Appendix A

User Menu Map

