



# CHEMTRAC

## HydroAct 4 User Manual

Chemtrac, Inc

Firmware Version: 1.19

November 15, 2017

Copyright © 2017 Chemtrac, Inc

All rights reserved. No part of this publication may be reproduced, distributed, or transmitted in any form or by any means, including photocopying, recording, or other electronic or mechanical methods, without the prior written permission of the publisher, except in the case of brief quotations embodied in critical reviews and certain other noncommercial uses permitted by copyright law.

<http://www.chemtrac.com>

# Contents

<b>1</b>	<b>Introduction</b> .....	<b>5</b>
<b>1.1</b>	<b>Safety Precautions</b>	<b>5</b>
1.1.1	Warnings used in this manual .....	5
1.1.2	Qualification and Training of Personnel .....	6
1.1.3	Important Safety Instructions .....	6
1.1.4	Safe Operation .....	7

## I

## Analyzer

<b>2</b>	<b>Overview</b> .....	<b>11</b>
<b>2.1</b>	<b>Safety Precautions</b>	<b>12</b>
2.1.1	Installation, Maintenance and Inspection .....	12
2.1.2	Unauthorized Modification .....	12
2.1.3	Impermissible Modes of Operation .....	12
2.1.4	Chemicals .....	12
<b>2.2</b>	<b>Technical Data</b>	<b>12</b>
<b>2.3</b>	<b>Installation</b>	<b>13</b>
2.3.1	Site Selection .....	13
2.3.2	Unpacking .....	14
2.3.3	Mounting .....	14
2.3.4	Electrical Connections .....	17
<b>2.4</b>	<b>Operation</b>	<b>18</b>
2.4.1	User Interface .....	18

2.4.2	Main Menu . . . . .	18
2.4.3	Home Screens . . . . .	19
2.4.4	User Authentication . . . . .	19
2.4.5	Analyzer Options . . . . .	20
2.4.6	Logs . . . . .	29

## II Options

<b>3</b>	<b>Sensors . . . . .</b>	<b>35</b>
<b>3.1</b>	<b>Dissolved Oxygen Sensor</b>	<b>35</b>
3.1.1	General Information . . . . .	35
3.1.2	Theory of Operation . . . . .	36
3.1.3	Installation . . . . .	37
3.1.4	Commissioning . . . . .	38
3.1.5	Calibration . . . . .	39
3.1.6	Operation . . . . .	41
3.1.7	Maintenance . . . . .	51
3.1.8	Troubleshooting . . . . .	53
<b>4</b>	<b>Controls . . . . .</b>	<b>55</b>
<b>4.1</b>	<b>PID Control</b>	<b>55</b>
4.1.1	General Information . . . . .	55
4.1.2	Operation . . . . .	57
<b>5</b>	<b>Outputs . . . . .</b>	<b>67</b>
<b>5.1</b>	<b>Analog Outputs</b>	<b>67</b>
5.1.1	General Information . . . . .	67
5.1.2	Technical Data . . . . .	67
5.1.3	Commissioning . . . . .	68
5.1.4	Operation . . . . .	68
<b>5.2</b>	<b>Relay Output</b>	<b>73</b>
5.2.1	General Information . . . . .	73
5.2.2	Technical Data . . . . .	73
5.2.3	Operation . . . . .	73

## III Documentation

<b>6</b>	<b>Warranty . . . . .</b>	<b>87</b>
<b>7</b>	<b>Returns . . . . .</b>	<b>89</b>
<b>7.1</b>	<b>Contact Details</b>	<b>89</b>

# 1. Introduction

This manual has been generated to accompany the serial number of the instrument as recorded on the front of this manual. It is specific to that serial number. Information regarding options or accessories that do not apply to this instrument do not appear in this manual. If you upgrade your firmware or your hardware please ask for a new manual to be generated for you.

This manual contains basic information to be noted during installation, operation and maintenance. It is therefore essential that this manual be read by the contractor before installing and commissioning the HydroAct 4, as well as by the relevant operating personnel/owner of the unit. It must remain available for reference at all times.

In addition to the general safety instructions under the main heading Safety Precautions, the special safety precautions outlined in other sections must also be observed.

This manual has been supplied electronically. A hard copy is available on request from hardware-support@chemtrac.com.

## 1.1 Safety Precautions

- Before attempting to unpack, set up, or operate this instrument, please read this entire manual.
- Make certain the unit is disconnected from the power source before attempting to service or remove any component.
- Make certain the unit is disconnected from other sources of force or pressure (for example, pneumatic or hydraulic), before attempting to service or remove any component.
- Failure to follow these precautions could result in personal injury and damage to the equipment.

### 1.1.1 Warnings used in this manual

This manual contains vital information relating to the safety of people and the environment, the analyzer and any equipment attached. These statements are identified by the following markings:

**Refers to an imminent danger or a potential hazardous situation. Non-compliance can lead to death or extremely serious injury.**

**Refers to a potential hazardous situation. Non-compliance can lead to injury or property damage.**

**Draws attention to supplementary information to make the work easier and ensure trouble-free operation. May also appear in conjunction with safety instructions which may endanger the analyzer and its operation if disregarded.**

## 1.1.2 Qualification and Training of Personnel

The personnel employed for installation, operation, inspection, and maintenance, must be suitably qualified for this work. The areas of responsibility, competence and supervision of the personnel must be precisely defined by the owner. Personnel who do not have the required know-how must be trained and instructed. If required, this can also be undertaken by the manufacturer/supplier on behalf of the owner.

In addition, the owner of the system must ensure that the relevant personnel are fully familiar with and have understood the contents of this manual.

## 1.1.3 Important Safety Instructions

When installing and using this electrical equipment, basic safety precautions should always be observed, including the following:

**Read and follow all instructions. Save these instructions.**

**To reduce the risk of injury, do not permit children to use this product.**

**Risk of electric shock. Connect only to a suitable isolated, hard wired electrical outlet. It is recommended that the outlet is protected by an RCD (Residual Current Detector) or is in any event in compliance with all local electrical regulations. Do not bury the electrical supply cable.**

**To reduce the risk of electric shock, replace damaged electrical cable immediately.**

**To reduce the risk of electric shock, do not use an extension cable to connect the unit to an electric supply; provide a properly located outlet.**

### 1.1.3.1 Hazards due to non-compliance

Failure to comply with the safety instructions may endanger not only people, but also the environment and the unit. The following hazards in particular may arise:

- Failure of major unit functions.
- Failure of specified methods for maintenance and repair.
- Danger to people due to electrical, mechanical and chemical effects.

#### **1.1.4 Safe Operation**

The safety instructions contained in this manual must be observed. The owner is responsible for ensuring compliance with local safety regulations.







# Analyzer

<b>2</b>	<b>Overview .....</b>	<b>11</b>
2.1	Safety Precautions	
2.2	Technical Data	
2.3	Installation	
2.4	Operation	



## 2. Overview

The HydroAct 4 is a compact electronic communication and control system. It is designed for use with many different measuring sensors. Any use other than the one described here compromises the safety of persons and the entire measuring system and is, therefore, not permitted. The manufacturer is not liable for damage caused by improper or non-designated use.

Every analyzer is carefully checked before leaving the factory. If for any reason, you are unhappy with your purchase, please contact the organization that you purchased the analyzer from or Chemtrac, Inc directly.

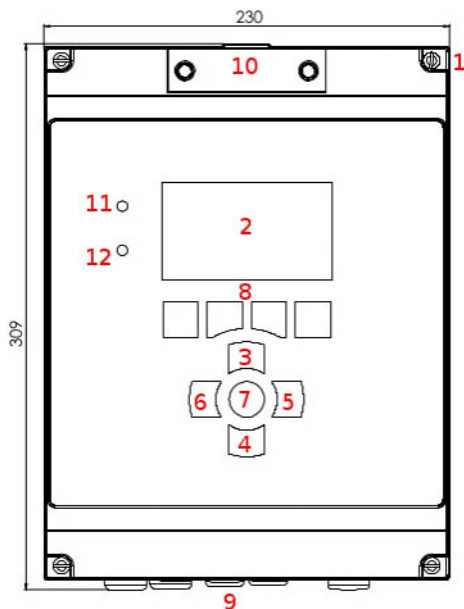

### HydroAct 4 Overview

1. Front panel screws (×4)
2. Display
3. Up button
4. Down button
5. Right button
6. Left button
7. Enter/Select button
8. Soft keys
9. Cable glands
10. Micro SD access
11. Power lamp
12. Indication lamp

## 2.1 Safety Precautions

### 2.1.1 Installation, Maintenance and Inspection

The owner must ensure that all maintenance, inspection and installation work is undertaken by authorized and duly qualified personnel who have also studied this manual.

- The HydroAct 4 must always be isolated before starting any work.
- Please be aware that the HydroAct 4 may be controlling chemical dosing and as such shutting down the HydroAct 4 without due regard to the systems it is controlling can lead to chemical release.

### 2.1.2 Unauthorized Modification

The device may only be modified or converted in consultation with the manufacturer. Genuine spare parts and accessories authorized by the manufacturer ensure greater safety.

### 2.1.3 Impermissible Modes of Operation

Usage other than as described in this manual will lead to the immediate cancellation of the warranty and any other manufacturer's liability.

### 2.1.4 Chemicals

Should the sensors attached to the HydroAct 4 be in contact with hazardous chemicals, great care must be taken when handling the sensors.

**Fire hazard. No parts are suitable for use in a hazardous rated area.**

**When working with this equipment, the accident prevention regulations applicable on site must be observed and the specified personal protective equipment worn.**

**Please unpack the equipment and ordered accessories carefully in order not to miss small parts. Immediately compare the scope of delivery to the delivery note. If there are any discrepancies, contact your supplier.**

## 2.2 Technical Data

**Power** 100-240VAC/0.25 A or 12VDC/0.8 A

**Fuse** 2A (100-240VAC)

**Display** 4.3" 480x272 24-bit color

**Inputs** Up to 4 configurable sensor inputs; 4-20mA, 4-20mA loop-powered, 0-2 VDC, +/- 2000 mV for pH, ORP, or ISEs, PT100, potentiometric, pulse and Modbus. Expandable to 16 inputs. Up to 8 digital inputs, expandable to 32

**Outputs** Up to 16 dedicated configurable analog outputs: 0-20mA, 4-20mA, 0-1 VDC, 0-10 VDC, 1-10 VDC. Unused inputs can be used as outputs allowing up to 32 output channels. Up to 32 SPST electromechanical relays rated 10A at 125 VAC, 3A at 250 VAC, 5A at 30 VDC

**Communication (Optional)** Modbus ASCII/RTU (RS485), Profibus DP, Modbus TCP (Ethernet), 2G/3G Modem

**Status Log** Over 1 million records

**Data Log** Internal - Single parameter data log or status message log over 1 million records

**Weight** 2kg

**IP Rating** IP65, Nema 4X

**Enclosure Material** ABS flame retardant  
**Seals** EPDM

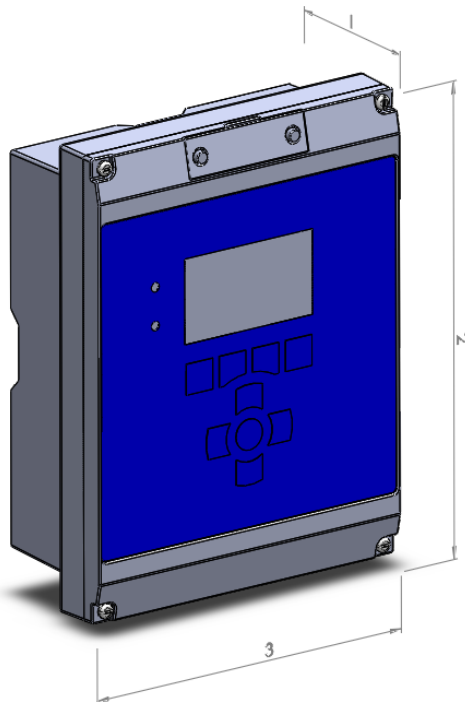

#### HydroAct 4 Dimensions

1. 103mm
2. 309mm
3. 230mm

## 2.3 Installation

**As with all instrumentation the installation and commissioning of this instrument is crucial to its safe and effective operation. This instrument must only be used for its purpose as outlined in this manual. It must be installed and commissioned in accordance with this manual and by trained, qualified personnel.**

### 2.3.1 Site Selection

Please choose a suitable location for the installation of the electronics. The choice of installation point on any site is a compromise and is best undertaken by an experienced installation engineer. The following is a list of the factors that need to be taken into consideration. This list is not intended as a check-list, neither is it implied that the list is complete.

- Ensure that the mounting allows access to all serviceable parts.
- Try to mount the electronics in a position where they are not habitually hosed down in a cleaning process.
- The electronics enclosure should be mounted away from sources of heat or direct sunlight.
- Consider the length of wiring runs when mounting the instrument.
- Try to keep the electronics away from substations, motors or other large EMI emitters.
- Consider whether the sample will be representative and well mixed.
- Consider sample line run times.
- Consider sample return points.
- In a plastic run, with a low conductivity liquid sample, consider earthing the sample.
- If the instrument is controlling a dosing pump, size the pump appropriately.

## 2.3.2 Unpacking

Please have a copy of your order with you when you unpack your instrument. All orders are checked when they leave the factory. Please check that you have all the parts that were ordered as soon as you open the box. If anything is missing, or damaged, please contact your supplier immediately. If the instrument needs to be returned for any reason please follow the return instructions given in this manual (refer to section 7).

**Please dispose of the packing in an environmentally responsible manner and in compliance with local regulations.**

## 2.3.3 Mounting

The HydroAct 4 enclosure is very versatile and can be wall mounted, panel mounted or mounted on a handrail or pole<sup>1</sup>. The HydroAct 4 electronics should be mounted so that:

- it is away from sources of heat or direct sunlight,
- it is vertical,
- there is sufficient clearance above to allow the enclosure compartment to be opened and removed,
- it is away from sources of vibration, and
- it will not be hosed down.

### 2.3.3.1 Wall Mounting

The analyzer enclosure can be screwed directly onto the wall. Mark and drill the holes as per the drawing below. Insert wall plugs and secure with appropriate screws (not supplied).

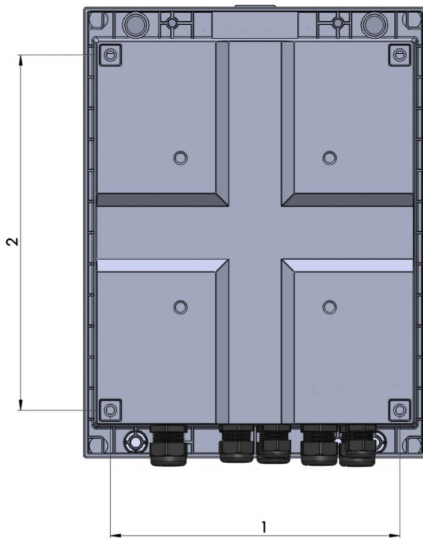

#### HydroAct 4 Wall Mounting

1. 194mm
2. 238mm

### 2.3.3.2 Panel Mounting

The analyzer enclosure can be panel mounted using the optional panel mount kit. The support bracket can be used as a template for cutting and drilling the panel.

<sup>1</sup>For panel or handrail mounting the enclosure requires optional mounting kits that can be ordered from Chemtrac.

### HydroAct 4 Panel Mounting

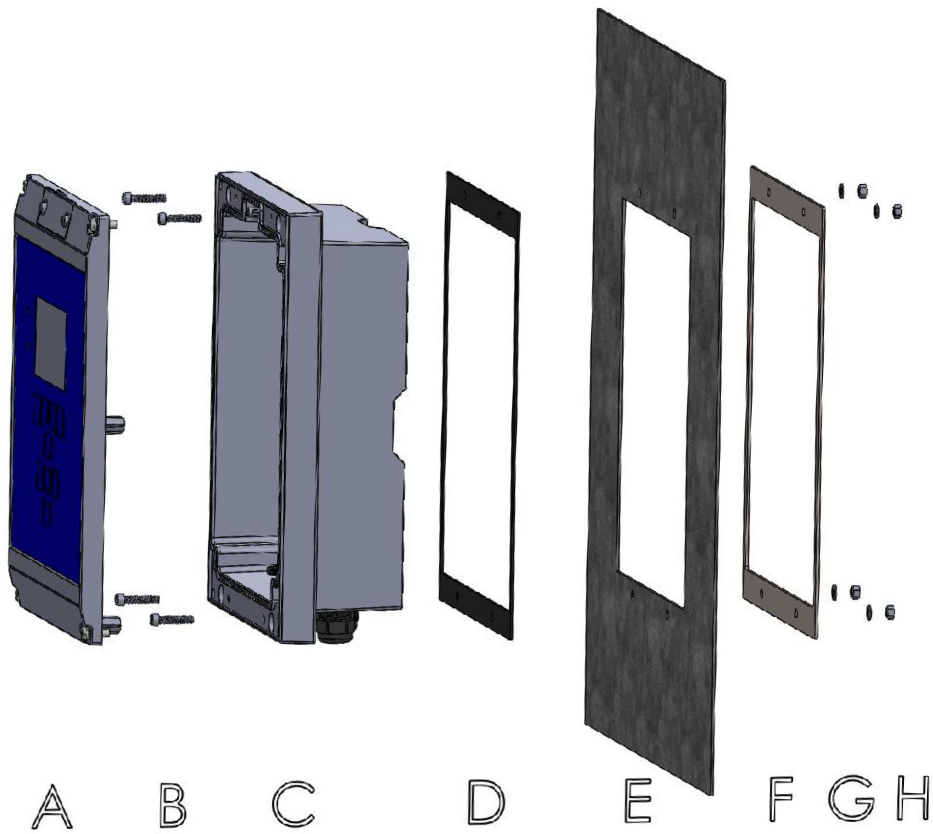

A - HydroAct 4 front section, B - Four M5 bolts, C - HydroAct 4 rear section, D - Rubber gasket, E - Panel, F - Support bracket, G - Four M5 washers, H - Four M5 nuts.

### 2.3.3.3 Handrail Mounting

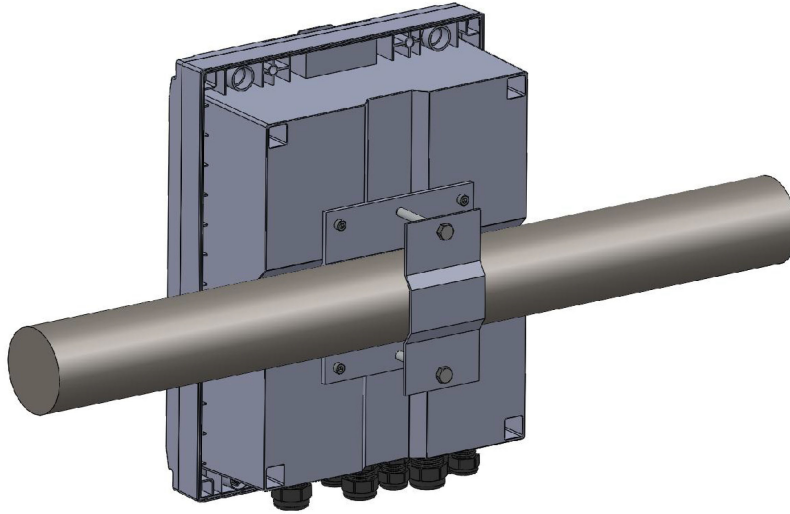

The analyzer enclosure can be handrail mounted using the optional handrail mount kit. By turning the brackets through 90° the analyzer can also be pole mounted.

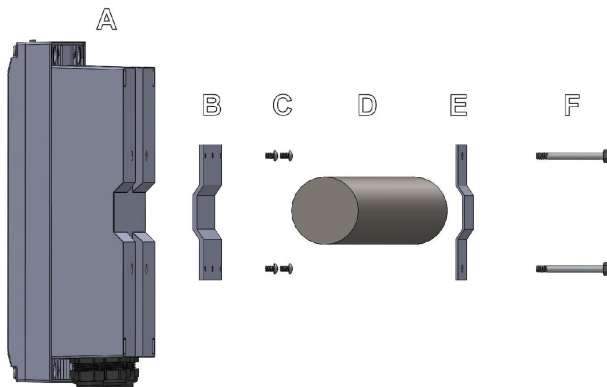

#### HydroAct 4 Handrail Mounting

- A HydroAct 4
- B Large bracket
- C Four M5×8mm bolts
- D Handrail
- E Small bracket
- F Two M6 bolts

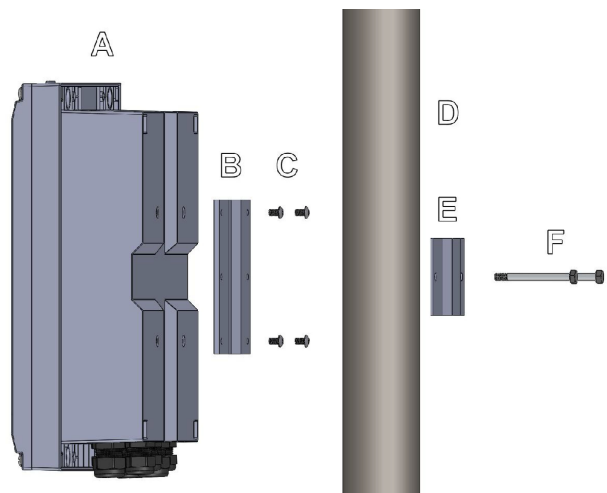

#### HydroAct 4 Pole Mounting

- A HydroAct 4
- B Large bracket
- C Four M5×8mm bolts
- D Pole
- E Small bracket
- F Two M6 bolts



### 2.3.4 Electrical Connections

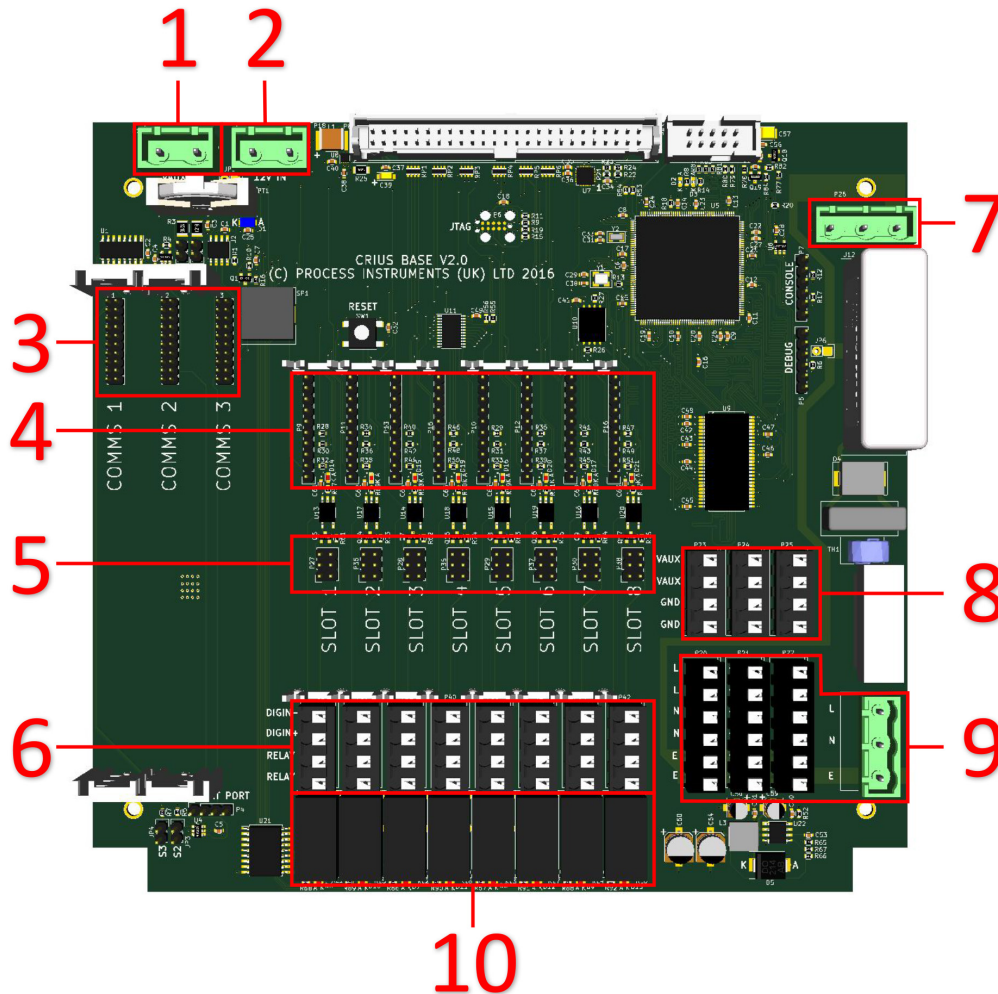

1. Auxiliary power from secondary PSU
2. 12V input from main PSU
3. Communication card slots
4. Sensor and output card slots
5. Digital input configuration jumpers
6. Relay and digital input connectors
7. AC Power to main PSU
8. Auxiliary power out<sup>2</sup>
9. AC power connectors
10. Electromechanical relays

The connections are made via press to open connectors or screw terminals. An insulated screwdriver can be used to operate the connector. Each instrument has a large number of possible wiring combinations depending on which sensors, inputs, outputs or communications are selected at the time of purchase. This is achieved by the use of expansion electronics cards specific to each role. These expansion cards are fitted to “Slots”.

The connections for sensors, inputs, outputs and communication cards are detailed in Part II of this

<sup>2</sup>If secondary PSU is not fitted, these connectors are linked to the main 12V PSU.

manual.

## 2.4 Operation

### 2.4.1 User Interface

The HydroAct 4 display is a 4.3", 480 × 272, 24-bit color display and is best viewed from directly in front. The user interface is accessed via nine buttons embedded in the membrane overlay. There are also two status LEDs, showing power and alarm status, and an audible buzzer.

The buttons all have a tactile feedback response. Holding the buttons in will inject multiple key presses of increasing speed until the button is released. In some cases holding a button will provide access to a different function. These are highlighted in the manual. The four buttons along the bottom of the screen, are defined for each screen by the legend above the button. The navigation and Select buttons below the display are always for navigation of the display. The Up and Down, Left and Right buttons are used for moving the "Select" target around the display.

The screen displayed once the system is started is either the default "Home" screen (see section 2.4.3), if configured, or the Main Menu.

### 2.4.2 Main Menu

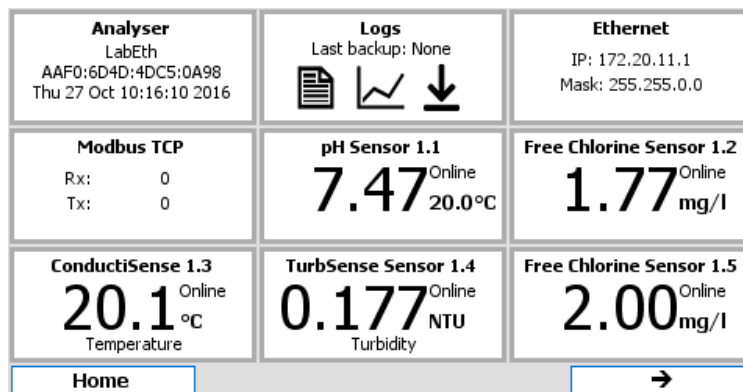

**Example Main Menu**

The Menu screen is a standard display in your HydroAct 4 and is a tile based display of all the different parts or "devices" that make up your analyzer. By using the Up, Down, Left, Right and Select button it is possible to navigate to any part of the analyzer by highlighting the icon and selecting it. Devices are firmware modules that control a physical device, such as a sensor, or a purely software construct, such as a PID control calculation. Some hardware devices have multiple device tiles associated with them. For example, an Ethernet communications card will add an "Ethernet" tile which allows physical interface to be configured and a "Modbus TCP" tile allowing access to the main communications protocol used on the interface.

There are two standard device tiles available on all analyzers, regardless of configuration. The "Analyzer" tile gives access to information and configuration options for the unit, e.g., selecting the language and setting the time and date. The "Logs" tile allows access to the status and data logs stored on the unit.

Selecting a device tile from the menu will open an overview or set up screen. The overview display gives the user key information for that device and may allow the entering of commonly changed variables. For example, an overview for a chlorine sensor will display the chlorine reading and sensor maintenance information, and offer the user a shortcut to calibrate the sensor.

Many screens will have an "Options" button. Pressing this button will produce a pop-up menu on the display. Some of the items on this menu will have a ► next to them indicating that there are further

menus accessible by highlighting the menu item and either pressing the Select button or the Right button.

### 2.4.3 Home Screens

Home screens are used to display information from more than one source on a single display. They are accessed by pressing “Home” from any screen displaying the soft-key and then by pressing the Left or Right button to scroll through the available Home Screens. On any Home Screen pressing Up and Down will highlight different aspects of the display which can then be accessed by pressing the “Select” button.

Home screens can simply show information about a single sensor:

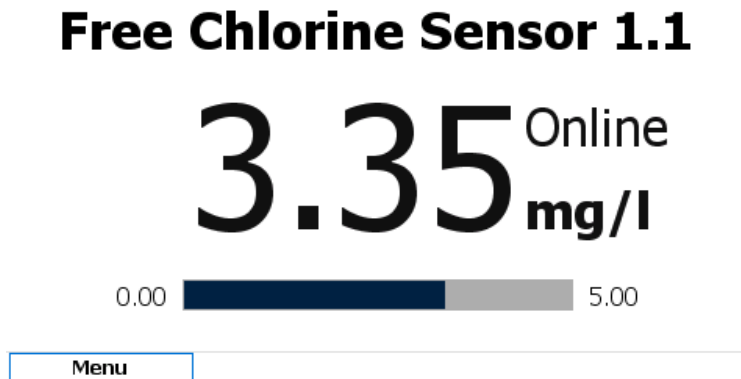

or several sensors readings and control outputs:

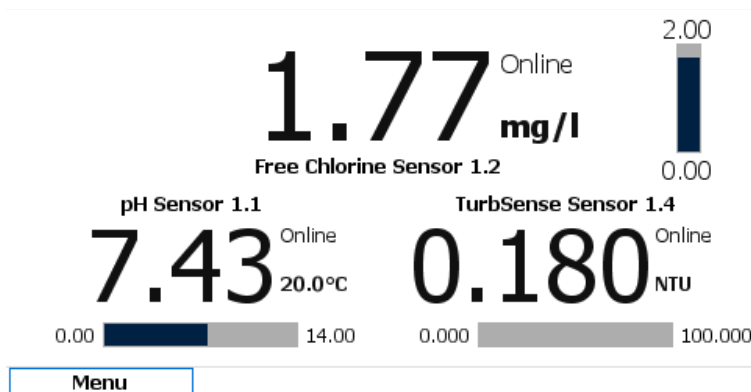

For details of how home screens are defined and configured see section 2.4.5.3.

### 2.4.4 User Authentication

When attempting to access a function that requires authentication you will be taken to the log in screen, where a user is selected and security code entered. Use the “Select” key to open the user drop down list, Up/Down to highlight the desired user and “Select” to move to the next step, the first box for the six digit security code entry will now be highlighted.

When entering a security code, all buttons except the fourth soft-key (top right) can be used for code entry. If the correct code is entered you will be presented with the tile requested. To indicate which user, if any, is currently logged in to the instrument, the user name will appear in the top right of the display. See section 2.4.5.4 for configuration of security options.

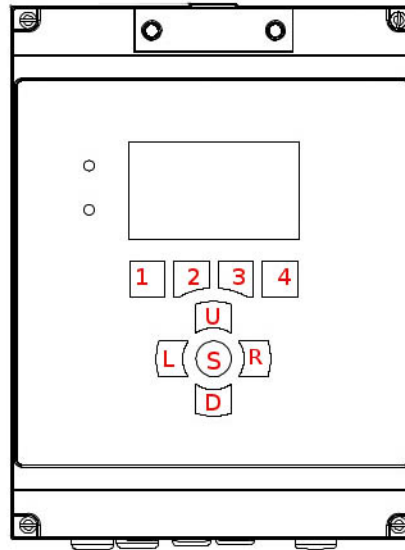

**HydroAct 4 Button Layout**

The analyzer is preconfigured with a default user called “user1” who has full access to the analyzer, with the default password of:

1, 1, 1, 1, 1, 1

From the button layout above.

To force a user to log out, press and hold the “Home” or “Menu” button for a few seconds until “Logout” is displayed. If default security access is enabled (see section 2.4.5.4) and different security access is required, press and hold the select button on the desired device tile in the main menu for a few seconds. The login screen will appear. Select the desired user and enter the password.

## 2.4.5 Analyzer Options

Selecting the Analyzer tile on the main menu will take you to the Analyzer Overview (below). From here you can access settings that relate to the analyzer setup. These typically do not affect the sensors, communications or control functions.

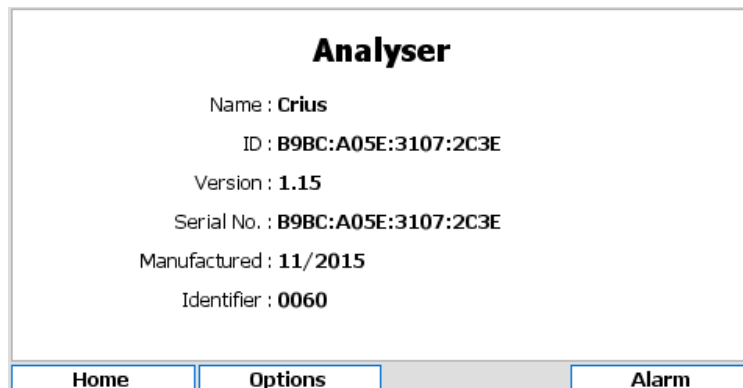

**Analyzer Overview**

### 2.4.5.1 Analyzer Setup

The date and time are used in the data logs and status logs of your controller and it is therefore important that they are set correctly. To modify the analyzer labels, time and date settings or language go to:

Options → Setup → Analyzer

**Name & ID** The Name and ID details allows the user to name the instrument in various ways. These tags are used to identify the instrument, e.g., when an instrument sends a text alarm, the Name and ID details are used to inform the recipient as to which instrument is in alarm. The Name would typically be the site name and the ID would typically refer to a specific analyzer.

**Language** The user interface of the HydroAct 4 can be set to any supported language. Use the drop down list to select the language of choice.

**Time Zone** Select the required time zone. The internal clock stores the time in UTC format. Therefore changing the time zone will change the current time. Daylight savings, if applicable for the selected time zone, will automatically be followed.

**Time** Set the required time by modifying the values using the up/down buttons

**Date** Select the date using the calendar widget that will appear when the date entry box is selected.

### 2.4.5.2 User Interface

Configuration options that affect the user interface are presented in tabbed windows. Use the keys marked “←” and “→” to move between tabs. The configuration is accessible by selecting:

Options → Setup → User Interface

**Buzzer** The buzzer will sound when a key is pressed or to indicate that the analyzer is in alarm. Use the checkbox to enable or disable the buzzer sounding.

**Backlight Timeout** In order to extend the life of the display a timeout can be set. At the end of the timeout the display will go dark. Any button press will turn the screen back on. Use the checkbox to enable or disable the backlight timeout and set the desired timeout using the up/down buttons. The timeout is in HH:MM:SS format.

**Home Button** On most displays the left button under the display can be set to take the user to the “Home” screen or the “Menu” screen.

**Blink highlighted** If this option is enabled, the element the user needs to look at blinks between two colors to attract attention.

#### 2.4.5.2.1 Menu

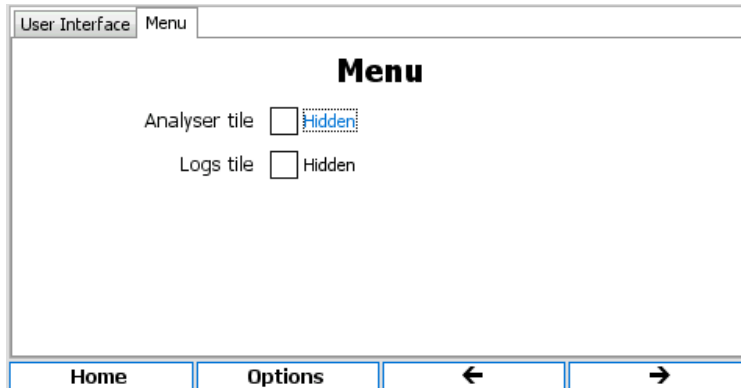

**Analyser tile** If the checkbox is ticked then the Analyzer tile will be hidden as default on the main menu.

**Logs tile** If the checkbox is ticked then the Logs tile will be hidden as default on the main menu.

#### 2.4.5.3 Home Screens

The HydroAct 4 has the capability to have multiple home screens which give the user options as to how the display provides information (see section 2.4.3). To set up a new home screen, edit or delete an existing home screen, select:

Options → Setup → Home Screen

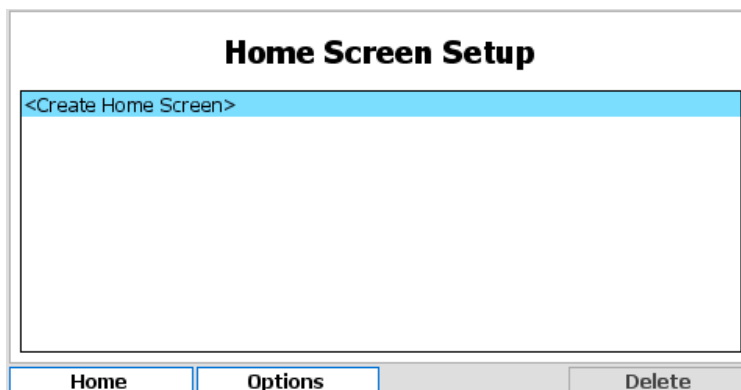

To delete a home screen highlight the home screen name with the up/down buttons and press “Delete”. Pressing and holding the “Delete” key will make the “Delete All” function available. A confirmation message box will appear before all home screens are deleted. To edit the home screen, again select the name, and press the select button. To create a new home screen, select “Create Home Screen” and press select.

**Create Home Screen**

Select home screen type and press Create

Type

Select the home screen type from the drop down list. Generic home screens allow up to 4 devices to be displayed in a variety of formats. Other home screen types are application-dependent and are described below, if applicable. For this example, select “Generic” and press “Create”.

**Home Screen Setup**

Name

Layout

1

Editing an existing Generic home screen or creating a new Generic home screen will display the above form. Select the desired layout as shown in the diagram below the layout selection box. The layout is made up of a series of windows that display selected information. The possible window arrangements for the layouts are as follows:

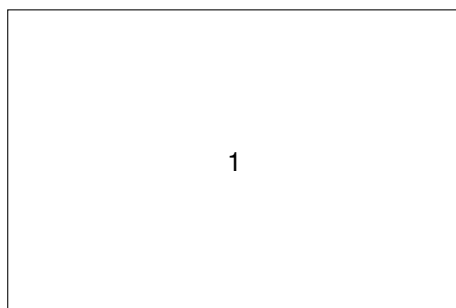

**Layout 1**



**Layout 2**

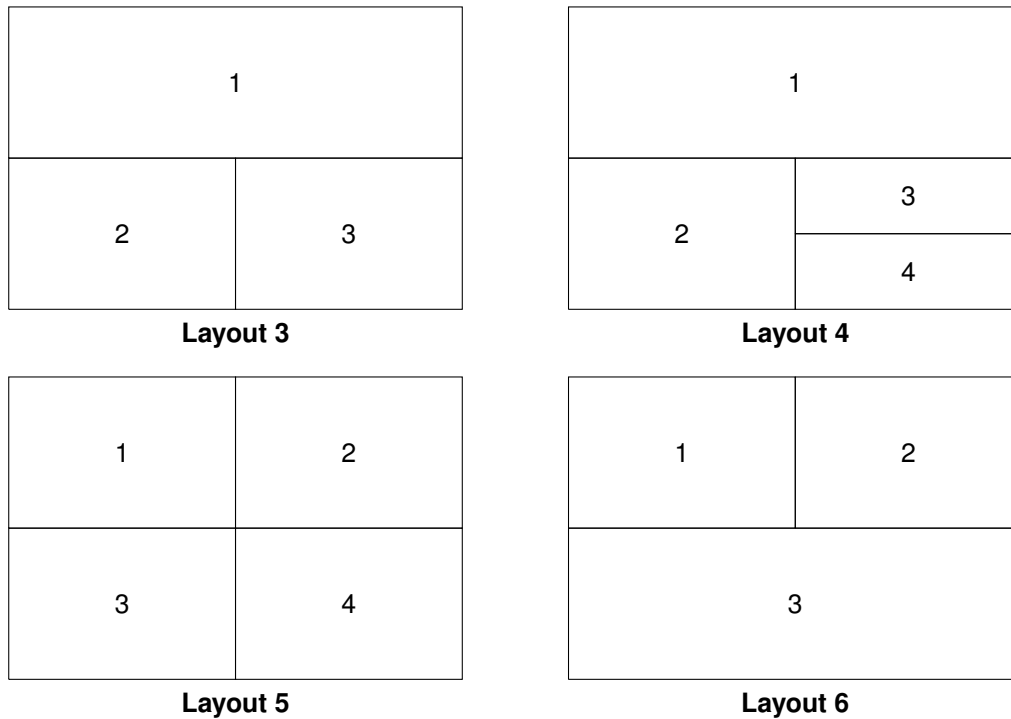

Each window can display information about a device or a data log graph. To select what is displayed in each window of a particular layout, move the selection to highlight the window and press the select button.

**Edit Window**

Select a module and window type to occupy home screen section

Type

Device

Home
Options
Done

**Type** Select the type of information to display in the selected window. Options are “Device” or “Data Log”.

**Data Log** If “Data Log” is selected in the type field, this option will be available. Select the data log to display.

**Device** If “Device” is selected in the Type field above, this option will be available. Select the device to display in the selected window.

**Window** If the device selected above has multiple types of display possible for this type of window, then this option will be available. Select the type of information to display.

#### 2.4.5.4 Security

To access the security setup options, select:

Options → Setup → Security



**Security Setup**

Login timeout 00 : 02 : 00

Default access  Enabled

System Advanced

Sensor Advanced

Signal Advanced

Output Advanced

Control Advanced

Event Advanced

Home Options

**Login Timeout** If no user activity is detected within this given time period while the main menu or home screen is displayed, then the current user will be logged out. The time is in HH:MM:SS format.

**Default Access** If enabled, then no user authentication will be attempted when accessing a device tile or using a quick access function from the home screen. Instead the user will be allowed access at the security level set out in the boxes below it.

#### 2.4.5.4.1 Security access levels

Access to many of the analyzer functions is secured using password protection. To allow flexible security profiles the HydroAct 4 is split into six access areas:

**System** Controls access to analyzer-specific settings and communication options.

**Sensor** Controls access to sensor devices.

**Signal** Controls access to signal devices, such as digital inputs.

**Output** Controls access to output devices, such as relays and analog outputs.

**Control** Controls access to control devices, such as PID.

**Event** Controls access to event devices, such as timers and schedulers.

With each of these areas, operations have been assigned to four security levels:

**None** No access to the assigned area is enabled.

**Basic** Users with this access level can see information and perform basic maintenance tasks. Users generally can not change any settings with this access level.

**Intermediate** Users with this access level can perform routine maintenance tasks and change common settings.

**Advanced** Users with this access level can perform all available actions.

Using this security model it is possible to assign specific tasks to individual users. For example, It is possible to allow a user to calibrate sensors (intermediate access for sensors), but not change PID settings (no access for controls). Access to restricted functions will require the entry of the operator's security password.

#### 2.4.5.5 Users

To add, remove users or modify access rights, select:

Options → Setup → Users

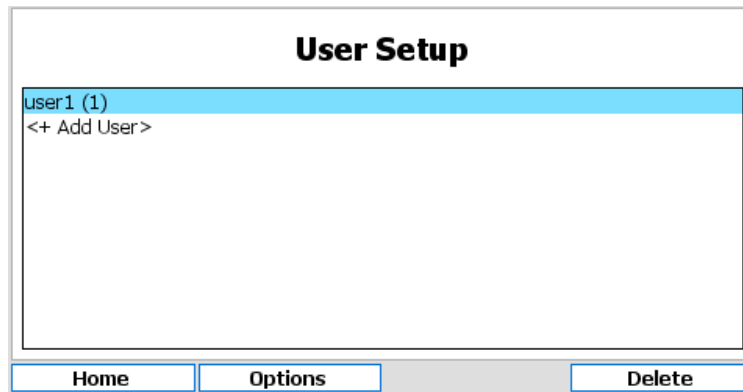

To add a user, highlight “<+ Add User>” and press the select button. Enter the desired user name and access rights. To set the password, press “Password” and follow the on screen prompts. To delete a user, highlight the user name and press “Delete”<sup>3</sup>. To modify a user account, highlight the user name and press the select button. The user name and security access rights will then be editable.

A user can change their own password by selecting the following and following the on screen prompts.

Options → Change Password

#### 2.4.5.6 Analyzer Information

Information regarding the analyzer hardware and software setup is useful for diagnosing problems and correctly configuring the analyzer. To access the hardware map, i.e., information about the hardware installed in the analyzer, select:

Options → Information → Hardware Map

Node	Type	Version	Serial No.
1	Base	1.15.00	B9BC:A05E:3107:2C3E
3	Undefined	0.00.00	0000:0000:0000:0000

Information given for each Node<sup>4</sup> includes board number, board type, firmware version number and unique serial number. Each enclosure in a system contains a base board. These boards are numbered 1, 5, 9 and 13. Board 1 is the master board with the screen and keypad attached. Each base board has three slots for communication boards, whose node number increments from the base board they are installed on. For example, the master board, or node 1, has communication slots with nodes numbered 2, 3 and 4.

Highlighting a base board and pressing the “Select” key will open a further information screen showing the I/O plugin cards installed, their location and hardware and software version numbers.

<sup>3</sup>A user can not delete their own user account. This prevents the possibility of having no privileged user accounts and effectively leaving an instrument in an unusable state.

<sup>4</sup>The mainboards and communication boards in an analyzer communicate over a CANBUS network. Each board has a unique Node number for identification on this network.

Node 1 - Base			
Slot	Type	Hardware Version	Software Version
1	pH Card	1.01.00	1.02.00
2	Analogue Input Card	1.01.00	1.03.00
8	Analogue Output Card	1.00.00	1.03.00

Home Options Back

The HydroAct 4 makes use of several internal read-only file systems as well as the micro SD card. Information regarding the file system usage can be viewed by selecting:

Options → Information → File Systems

File Systems		
Name	Used	Total
/bin	0.79MB	0.79MB
/opt	0.50MB	0.50MB
/usr	2.43MB	2.43MB
/var	0.00MB	1.73MB
config	0.00MB	0.12MB
/mnt	20.44MB	1914.62MB

Home Options

All entries other than “/mnt” are internal read-only file systems and the information may be useful for technical support inquiries. The “/mnt” file system refers to the micro SD card and a total size of 0.00MB indicates that the card is missing or not detected.

The device list shows which software modules are installed and active on the analyzer. To access this information, select:

Options → Information → Device List

Each installed device is listed. Use the Up and Down keys to scroll through the list.

#### 2.4.5.7 Alarm Settings

When the analyzer detects an error condition, it will enter an alarm state. This will be indicated on the screen and sounded using the buzzer. To access the alarm configuration, select:

Options → Alarm → Setup

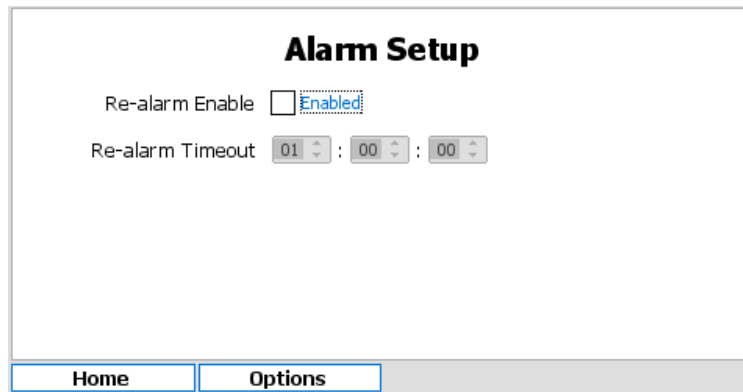

The “re-alarm” feature can be enabled and the timeout set. If the analyzer is in alarm and that alarm is acknowledged (see below), then the analyzer will return to the alarm state after the timeout has expired if the error condition has not been rectified. The exact reason for the active alarm is shown by selecting:

Options → Alarm → Message

When the analyzer is in alarm, the message shows the time and date of when the message was updated and an “Ack” button silences the alarm and prevents any further alarm SMS messages<sup>5</sup> being generated. The alarm message will change to indicate the alarm has been acknowledged.

#### 2.4.5.8 Service Options

Service options are used to gather information for technical support personnel. Other options allow firmware upgrades and factory reset of configuration information. Operations in this menu should only be accessed when requested by a service engineer.

#### 2.4.5.9 Device Codes

Device codes enable firmware modules. Adding new hardware or software features usually requires adding device codes. Devices codes can be entered directly using the user interface or imported from a MicroSD card. Technical support will provide instructions should this need to be done outside of the factory.

#### 2.4.5.10 Backup, Clone and Restore Configuration

##### 2.4.5.10.1 Backup

To create an analyzer backup navigate to:

Analyzer → Options → Backup → Backup

Select an existing file to overwrite or select “+New File” and select “Next”. If creating a new file, enter the desired filename (by default the date is included in the filename). Then select “Next”. When notified that the backup file has been created select “OK”.

##### 2.4.5.10.2 Restore/Clone

To begin a restore/clone operation navigate to:

Analyzer → Options → Backup → Restore

Select the file to restore/clone from and select “Next” and then “OK”. If this is the analyzer on which the backup file was created a restore operation will occur. If this is a different analyzer a clone operation will occur.

<sup>5</sup> Available if a 2G/3G Modem option is installed

Configuration Files	Restore	Clone
Analyzer Settings (Name, Alarm, Users, etc)	Yes	Yes
Communications Card Settings <sup>6</sup>	Yes	Yes
Data Logs Setup <sup>7</sup>	Yes	No
Home Screens	Yes	No
Device Codes	Yes	No <sup>8</sup>
Device Settings	Yes	Yes
Modbus Maps	Yes	Yes

## 2.4.6 Logs

Selecting the log tile from the main menu will display a secondary logs menu. These available options are; Backup Logs, Status Log and Create Data Log.

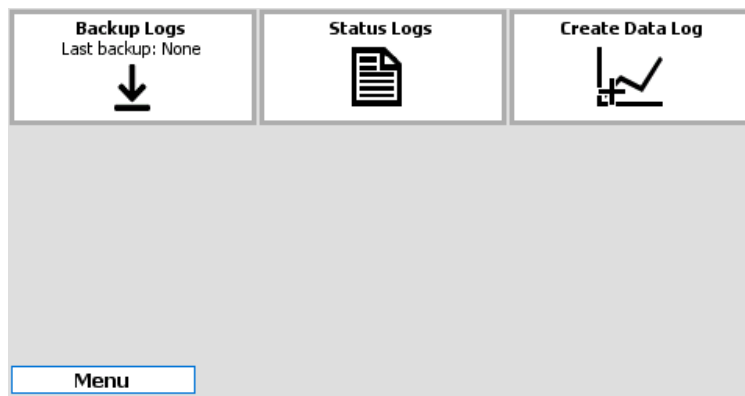

If any data logs are defined, each will be displayed as its own file.

### 2.4.6.1 Backup Logs

Logs can be backed up by selecting this tile. The screen will display the last time logs were successfully backed up. With a SD card inserted in to the analyzer, press the "Backup" button to begin. Log entries since the last successful backup will be written to the SD card. A progress bar will display the backup task progress and a message displayed to indicate the result.

### 2.4.6.2 Status Log

Selecting the Status Log tile will display the Status Log messages. These will include important information such as recording when calibrations are performed, users log in and any error messages:

<sup>6</sup>Communication cards must be present in the same order for restore/clone to function.

<sup>7</sup>All data log data will be cleared

<sup>8</sup>Same device codes must already be present on the analyzer for device configurations to be cloned successfully.

Status Logs		
ID	Time	Message
2351	24/02/2017 12:55:51 GMT	pH Sensor 1.2 error: Sensor failed to read input signal
2350	24/02/2017 12:55:51 GMT	Free Chlorine Sensor 1.1 error: Sensor failed to read input s
2349	24/02/2017 12:52:07 GMT	Login by user user1
2348	24/02/2017 11:10:28 GMT	User logged out
2347	24/02/2017 06:21:22 GMT	Login by user user1
2346	24/02/2017 06:19:12 GMT	pH Sensor 1.2 error: Sensor failed to read input signal
2345	24/02/2017 06:19:12 GMT	Free Chlorine Sensor 1.1 error: Sensor failed to read input s
2344	24/02/2017 06:16:02 GMT	Login by user user1
2343	24/02/2017 05:40:59 GMT	User logged out
2342	24/02/2017 05:38:54 GMT	Login by user user1
2341	20/02/2017 07:24:58 GMT	User logged out

Home    Back    Clear    Download

Use the arrow keys to scroll up, down, left and right. Press “Clear” to delete the current status log messages and truncate the status log. Press “Download” to save the status log to SD card.

### 2.4.6.3 Data Logs

#### 2.4.6.3.1 Creating a Data Log

To create a new data log, select “Create Data Log”.

New Data Log	
Name	<input type="text" value="New Data Log"/>
Interval	<input type="text" value="30 Minutes"/>

Back    Next

Enter the name to identify the data log and the log interval. Available options are 1, 2, 5, 10, 15, 20, 30 minutes or 1 hour. Press “Next” to continue.

Items Logged	
<input type="checkbox"/>	Free Chlorine Sensor 1.1 (Free Chlorine)
<input type="checkbox"/>	pH Sensor 1.2 (pH)
<input type="checkbox"/>	PID Controller 1.1 (Primary Output)

Back    None    All    Done

Select from a list of available parameters, signal inputs and control outputs to populate the data log. Highlight the desired measurements or press “All” to highlight all available measurements. Up to the first 4 measurements selected will be displayed on the data log graph. Press “Done” when finished. The data log will be created and data collected.

**2.4.6.3.2 Viewing a Data Log**

Each data log configured will be displayed as a tile in the Logs menu. Select the data log of interest to view the data.

### Overview

Name

Interval

Items Logged

Free Chlorine Sensor 1.1 - Free Chlorine

pH Sensor 1.2 - pH

PID Controller 1.1 - Primary Output

The overview allows the renaming of the log and changing of the log interval. The “Delete” button will remove the log completely and prevent any further data logs being collected. The “Clear” button will truncate the data log and remove any historic data. The "Download" button allows the data log to be saved to SD card as comma-separated values.

### Default

ID	Time	Free Chlorine Sensor 1.1 (Free Chlorine) [1/3]
82073	21/03/2017 14:45:00 GMT	1.06
82072	21/03/2017 14:30:00 GMT	1.06
82071	21/03/2017 14:15:00 GMT	1.08
82070	21/03/2017 14:00:00 GMT	1.09
82069	21/03/2017 13:45:00 GMT	1.08
82068	21/03/2017 13:30:00 GMT	1.10
82067	21/03/2017 13:15:00 GMT	1.12
82066	21/03/2017 13:00:00 GMT	1.11
82065	21/03/2017 12:45:00 GMT	1.13
82064	21/03/2017 12:30:00 GMT	1.14
82063	21/03/2017 12:15:00 GMT	1.14
82062	21/03/2017 12:00:00 GMT	1.16

To view the data log values collected, press the “Data” button. A table of recorded values will be displayed. Use the arrow keys to scroll up, down, left and right.

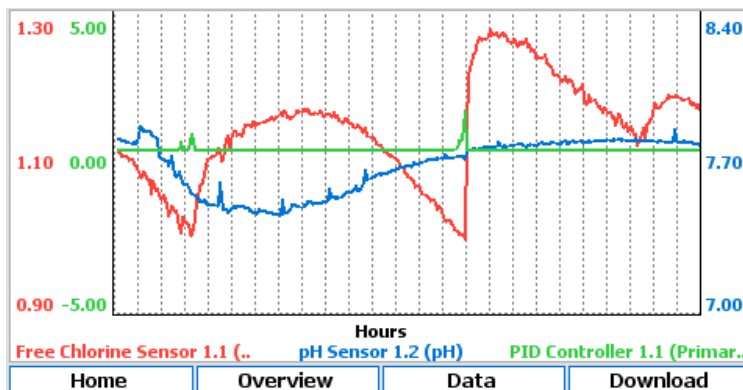

To view the data log graph, press the “Graph” button. The legend shows the line style for each measurement and axis.





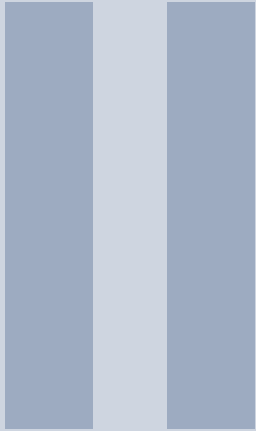

# Options

<b>3</b>	<b>Sensors</b> .....	<b>35</b>
3.1	Dissolved Oxygen Sensor	
<b>4</b>	<b>Controls</b> .....	<b>55</b>
4.1	PID Control	
<b>5</b>	<b>Outputs</b> .....	<b>67</b>
5.1	Analog Outputs	
5.2	Relay Output	



## 3. Sensors

### 3.1 Dissolved Oxygen Sensor

#### 3.1.1 General Information

The Dissolved Oxygen Sensor is a rugged, reliable sensor designed to deliver accurate dissolved oxygen data across a wide measuring range. The sensor features the latest technology for dissolved oxygen measurement.

##### 3.1.1.1 Health and Safety

The Dissolved Oxygen Sensor is designed to measure the dissolved oxygen (DO) in water. The sensor is often installed into waste water applications. Health and Safety precautions should be taken to protect against this waste water when handling a used sensor.

**Before making or breaking any electrical or signal connections, ensure that the instrument is isolated from the electrical supply.**

##### 3.1.1.2 Environmental Considerations

The sensor tip has gold pins and an inner lens. Inside the sensor there are electronics. Please use this product in a manner sensitive to the environment and at the end of its life dispose or recycle in a manner appropriate at that time in compliance with local regulations.

### 3.1.2 Theory of Operation

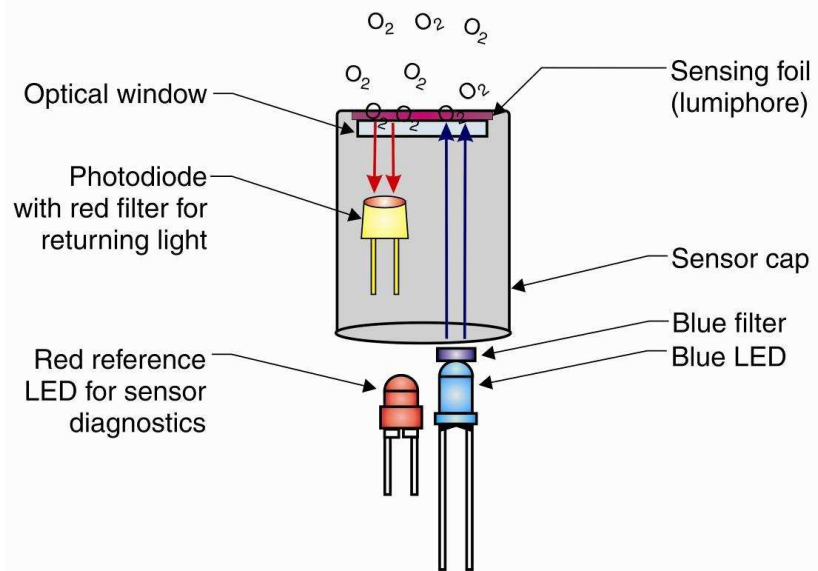

The sensor measures dissolved oxygen using the principle of “dynamic luminescence quenching”. The sensor uses lifetime-based optical fluorescence technology to provide an extremely stable, accurate, low-maintenance dissolved oxygen sensor. The sensing foil (lumiphore) is activated, or excited when illuminated with a blue light. When activated, the lumiphore then emits red light in an intensity that is inversely proportional to the amount of oxygen present in the water. There is also a time delay between the peak emission of blue light and peak response of fluoresced red light. The amount of delay is inversely proportional to the amount of oxygen present. This time delay can be expressed as a phase shift between the wave patterns of incident blue light and the fluoresced red light. This is in turn reported by the electronics into an oxygen concentration, as a ppm or mg/l reading. The advantages of this technology are that it is more stable than traditional electrochemical devices and far more resistant to abrasion.

#### 3.1.2.1 Parts Supplied

Keep the packaging for the sensor. In case of repair or warranty return the sensor in this package. Check that the delivery is intact. In case of damage please contact your supplier. Check that the delivery is complete by comparing with the list of parts below.

- Rugged 15 meter cable (Unless other length specified).
- Black probe body with removable nose cone.
- Optical DO sensor cap.
- Calibration tube with storage cap and calibration cap.

#### 3.1.2.2 Technical Data

##### 3.1.2.2.1 Sensor

**Range** 0 to 50 mg/l concentration; 0 to 200% saturation.

**Accuracy**  $\pm 0.1$  mg/l, 0 to 8 mg/l.  $\pm 0.2$  mg/l, 8 to 20 mg/l.  $\pm 10$  % of reading, 20 to 50 mg/l.

**Resolution** 0.01 mg/l.

**Response time**  $T_{90} < 45$  sec;  $T_{95} < 60$  sec at 25 °C

**Storage conditions** -5..60 °C

**Temperature sensor** 0..50 °C.

**Accuracy**  $\pm 0.1$  °C typical.

**Resolution** 0.01 °C.

**Power Consumption** 50 mA at 12 VDC.

**Measure Current** 6mA typical at 24 VDC.

**Idle Current** 160 $\mu$ A typical at 24 VDC.

**Maximum cable length** Up to 1200m.

**Cable Options** 10m fixed stripped and tinned (standard). Twist-lock connector with user selectable cable length (optional).

**Mounting thread** 1 $\frac{1}{4}$ "

**IP rating** IP-67 with sensor cap off, IP-68 with sensor cap installed.

**Compliance** Heavy industrial, IEC 61000-6-2:2005

**Maximum pressure** 150 PSI from 0..50 $^{\circ}$ C, 300 PSI 25 $^{\circ}$ C

**Interferences** Alcohol <5%, hydrogen peroxide <3%, sodium hypochlorite <3%, gaseous sulfur dioxide and gaseous chlorine.

**Diameter** 44mm

**Length** 203mm

#### 3.1.2.2.2 Sensor Cap

**Usage life** 2 years typically

**Shelf life** 24 months from date of manufacture (install within 12 months of manufacture).

**Storage conditions** 1..60 $^{\circ}$ C, in factory container.

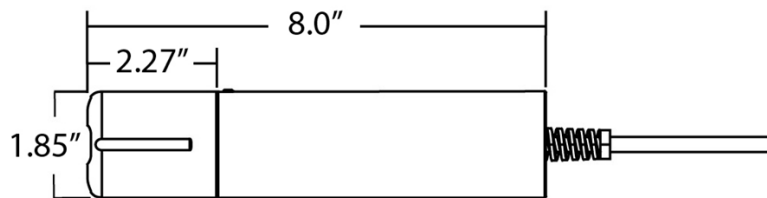

### 3.1.3 Installation

The cable end of the probe is internally threaded (1 $\frac{1}{4}$ NPT) and can be attached to a male threaded pipe. When deployed, make sure that the nose cone and thermistor are completely submerged.

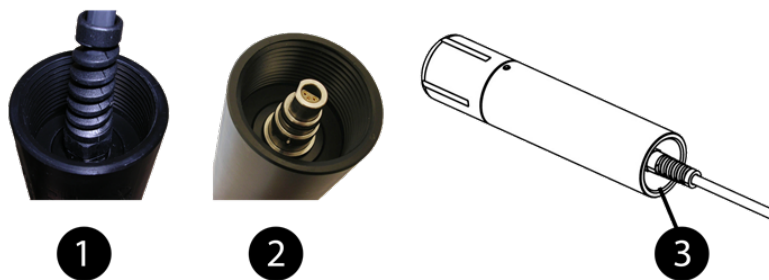

1. 10 m cable attached
2. Twist-lock connector
3. 1 $\frac{1}{4}$ NPT threading

In all cases the sensor should be mounted such that:

- The sensor installation must be stable, secure and away from vibration.
- Ensure that the mounting allows access to all serviceable parts.
- Consider the length of the wiring runs when mounting the instrument.
- Keep the sensor and analyzer away from substations or other large EMI emitters.

- The cable end of the Dissolved Oxygen Sensor sensor is internally threaded and can be attached to a male threaded pipe. When installed, make sure that the nose and thermister (silver dot on the side of sensor body) are completely submerged.
- Sensor must be installed at least a 30° angle from vertical.

### 3.1.4 Commissioning

#### 3.1.4.1 Preparation of the Sensor

Please read and carefully follow the instructions below before assembling or maintaining the sensor. Failure to follow these instructions may result in damage to the sensor.

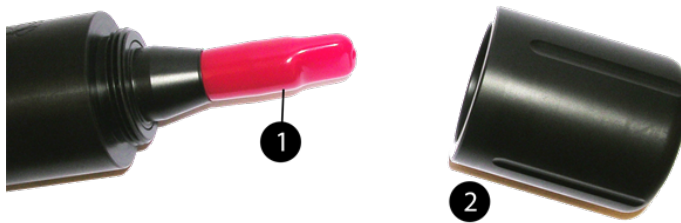

Remove the sensor from the box and other packaging materials. Unscrew the nose cone from the sensor and remove the red protective dust cap from the sensor. Save the dust cap for later use.



Remove the sensor cap from its storage sleeve. Align the arrow on the sensor cap with the index mark on the sensor and firmly press the cap onto the sensor, without twisting, until it seals over the probe body.

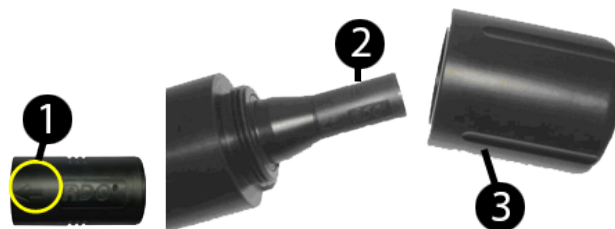

1. Alignment arrow on cap.
2. Cap installed over lens.
3. Nose cone.

Align the arrow on the sensor cap with the index mark on the sensor and firmly press the cap onto the sensor, without twisting, until it seals over the probe body. Avoid allowing moisture, including atmospheric humidity, inside the sensor cap. Keep the sensor cap in its sealed packaging until installation. Make sure that the O-ring grooves are dry and the O-ring is not rolled or pinched inside the sensor cap.

**The sensor cap has a lifespan of 2 years after the first reading has taken place.**



Screw on the nose cone, make sure it is tight so that the O-rings seal.

### 3.1.5 Calibration

To calibrate the Dissolved Oxygen Sensor, the sensor must be removed from the process and calibrated using the calibration chamber provided. Calibration requires a 100% saturated environment in water-saturated air and an optional 0% saturated environment using an oxygen scavenger. To navigate to the calibration process, select:

Options → Maintenance → Calibration

#### 3.1.5.1 100% Saturated Environment

Remove the storage cap from the top of the calibration chamber and replace with the calibration cap (cap with vent hole).



1. Storage cap.
2. Vented calibration cap.

Place the sponger wafer in the bottom of the calibration chamber and saturate with approximately 10mL water.



The water temperature should be similar to the sample temperature. Gently dry the sensor and sensing foil with a soft paper towel, making sure there is no water on the body of the sensor and that the sensing foil is free of water and fouling. Place the sensor in the calibration chamber, so that the sensing foil is about 25mm above the surface of the water.

Do not leave the sensor in the calibration chamber for more than 30 minutes as this can allow

condensation to form on the surface of the sensing foil, giving false low readings after calibration. If condensation does occur, remove the sensor, dry the foil and replace in the calibration chamber.

**Do not wet the sensor/foil. Ensure there are no water droplets on the surface of the sensing foil when in the calibration chamber.**

Following the on-screen instructions, allow 5 to 10 minutes for temperature stabilization. When readings have stabilized, press “Next” and collect the calibration data. When complete, the analyzer will ask if a 0% saturated environment calibration is required. Select “Yes” to perform the optional step below, or “No” to apply the single point calibration.

### 3.1.5.2 0% Calibration Environment

Place the calibration cap (cap with vent hole) onto the top of the calibration chamber. Remove the water-saturated sponge from the calibration chamber. Fill the calibration chamber to the upper fill line with approximately 60ml of fresh sodium sulphite solution. To make up a suitable solution use the tables below to determine the correct concentration.

The first table is used to determine the oxygen concentration of water at the calibration temperature. This figure is then used in the second table to determine the amount of sodium sulphite required to quench the oxygen present.

Temp. (°C)	Solubility (mg/L)	Temp. (°C)	Solubility (mg/L)
0	14.6	16	10
1	14.2	17	9.8
2	13.8	18	9.6
4	13.1	19	9.4
5	12.8	20	9.2
6	12.5	21	9
7	12.2	22	8.9
8	11.9	23	8.7
9	11.6	24	8.6
10	11.3	25	8.4
12	10.9	26	8.2
13	10.6	27	8.1
14	10.4	28	7.9
15	10.2	29	7.8

With the oxygen concentration known, use the table below to determine the sodium sulphite concentration required. For example, 60ml of water at 21 °C will require 9.36mg/l of sodium sulphite (i.e., 561.6mg dissolved in to 60ml) to quench the dissolved oxygen).



DO (mg/L)	Na <sub>2</sub> SO <sub>3</sub> (mg/L)	DO (mg/L)	Na <sub>2</sub> SO <sub>3</sub> (mg/L)
0	0	13	13.52
1	1.04	14	14.56
2	2.08	15	15.6
3	3.12	16	16.64
4	4.16	17	17.68
5	5.2	18	18.72
6	6.24	19	19.76
7	7.28	20	21.84
8	8.32	22	22.88
9	9.36	23	23.92
10	10.4	24	24.96
11	11.44	25	26
12	12.48		

Add the solution to the calibration chamber and completely submerge the nose cone of the sensor, making sure that the temperature thermistor (silver dot on the side of the sensor body) is also completely submerged under the surface of the solution.



Do not allow the sensor to rest on the bottom of the calibration chamber. Leave at least 15mm between the surface of the sensing foil and the bottom of the chamber. Allow at least five minutes for the temperature to stabilize prior to calibration.

The unit will ask you to place the probe in a 0% saturation solution. Once this has been done as described above wait for the reading to stabilize (this often takes 5-10 minutes). Once stable, press "Next". The HydroAct 4 will save the calibration. Once calibrated, remove the sensor, and thoroughly rinse to remove any excess sodium sulfite.

### 3.1.6 Operation

When selecting the Dissolved Oxygen Sensor tile from main menu, the sensor overview screen will be displayed. This shows the current Oxygen Concentration, Oxygen Saturation and Oxygen Partial

Pressure values. The table shows the date of the last calibration and due date of the next. The buttons allow access to the sensor options, quick access to the calibration functions and manual control of the sensor hold feature.

### Sensor Overview

#### OxySense Sensor 1.1

Oxygen Concentration	Oxygen Saturation	Oxygen Partial Pressure
8.66	96.3	147.0
mg/l	%	Torr

Status: Online    Temperature: 20.6°C    Sensor: OK

<b>Maintenance</b>	<b>Last</b>	<b>Due</b>
Calibration	Never	Disabled

Home
Options
Hold
Calibrate

### 3.1.6.1 Sensor Setup

Sensor settings are accessed by selecting:

Options → Setup → Sensor Setup

Name

Display  Show    Enabled  Yes  
 Hide     No

Flow Signal

Flush Signal

Process Signal

Hold Delay  :  :

Home
Options

**Name** Edit the sensor name used to identify the sensor. Up to 25 characters.

**Display** Options are “Show” or “Hide”. This relates to whether the tile for this sensor will show on the Menu screen.

**Enabled** Options are “Yes” or “No”. If “No” is selected the sensor will not update and will not generate alarms.

**Flow Signal** Allows a flow switch to be associated with a sensor. Options are “Disabled” or selectable from a list of available digital inputs.

**Flush Signal** Allows an external flush signal to be associated with a specific sensor. The flush signal will notify the sensor that an automatic cleaning operation is underway. Options are “Disabled” or selectable from a list of available digital inputs.

**Process Signal** Allows an external process signal to be associated with a specific sensor and allows the external signal to enable or disable a sensor. Options are “Disabled” or selectable from a list of available digital inputs.

**Hold Delay** The Sensor hold delay is used following a flush event to allow the sensor reading to recover. Time entered in HH:MM:SS format.

### 3.1.6.2 Modbus Setup

Modbus settings can be accessed by selecting:

Options → Setup → Modbus Setup

**Slave Address** Enter the Modbus slave address of the sensor. This is unlikely to change from 1.

**Mode** Select the Modbus serial mode. Options are “ASCII” or “RTU”.

**Baud Rate** Select the RS485 baud rate. Options are standard baud rates between 1200 and 115200.

**Parity** Select the RS485 parity bit option. Options are “Odd”, “Even”, or “None”

**Stop Bits** Select the number of stop bits. Options are 1 or 2.

**Termination Enabled** Use the checkbox to enable the use of a termination resistor.

**Byte Swap** To support different microprocessors that store data in different formats, the HydroAct 4 can alter the data it sends and receives to match the format expected by the sensor. The byte swap option allows the order of bytes in the 16-bit registers to be reversed.

**Word Swap** When two 16-bit registers are combined for larger data types, e.g., floating-point number representations, this option reverses the order of the two 16-bit words to match the format expected by the sensor.

### 3.1.6.3 Compensation Setup

The sensor can be compensated for salinity, if used in seawater or brines, and atmospheric pressure, if installed at altitude. To change the compensation settings from fresh water at sea-level, select:

Options → Setup → Compensation Setup

**Pressure** Enter the atmospheric pressure at the installation site in mbar.

**Salinity** Enter the salinity of the sample in practical salinity units.

### 3.1.6.4 Oxygen Concentration

Parameter settings are accessed by selecting:

Options → Setup → Oxygen Concentration

The screenshot shows the 'Parameter Setup' interface for 'Oxygen Concentration'. The 'Type' dropdown is set to 'Oxygen Concentration'. The 'Precision' is set to 2 Digits, and the 'Units' are set to mg/l. The 'Offline Value' is set to 0.00. The 'Averaging' option is set to 'Disabled'. The 'Length' is set to 60, and the 'Delay' is set to 0500 ms. At the bottom, there are 'Home' and 'Options' buttons.

**Type** A selectable list of parameter types. The selection made here will affect what options are available below.

**Name** Available if “User defined” is selected as the type. The name can be up to 25 characters.

**Units** If “User defined” is selected above, set the units using the custom units’ entry screen that will be displayed when pressing the select button. Otherwise select from an appropriate list of units for the parameter type.

**Precision** Select the number of digits following the decimal point to display. This should be appropriate for the measurement. Options are 0 to 5.

**Offline Value** This is the value reported by the parameter when in ‘Offline’ mode, for example, if the sensor is in alarm. Options are within the range of the parameter.

**Averaging** Enables or disables a rolling average for the parameter to smooth the reading. Options are “Enabled” or “Disabled”. Selecting “Enabled” will allow editing of the following two form fields.

**Length** Enter the number of data points in the rolling average buffer. Options are 2..60.

**Delay** Enter the delay between collecting data points for the rolling average<sup>1</sup>. Options are 200..5000ms.

### 3.1.6.5 Temperature

Parameter settings are accessed by selecting:

Options → Setup → Temperature

The screenshot shows the 'Parameter Setup' interface for 'Temperature'. The 'Type' dropdown is set to 'Temperature'. The 'Precision' is set to 1 Digits, and the 'Units' are set to °C. The 'Offline Value' is set to 0.0. The 'Averaging' option is set to 'Disabled'. The 'Length' is set to 60, and the 'Delay' is set to 0500 ms. At the bottom, there are 'Home' and 'Options' buttons.

<sup>1</sup>An averaging delay of 2000ms with a length of 30 will result in a rolling average of 1 minute (30 × 2s) with a reading taken every 2 seconds. If averaging is enabled it will apply to all aspects of the parameter value, e.g., it will apply to the value displayed, logged and outputted.

**Type** A selectable list of parameter types. The selection made here will affect what options are available below.

**Name** Available if “User defined” is selected as the type. The name can be up to 25 characters.

**Units** If “User defined” is selected above, set the units using the custom units’ entry screen that will be displayed when pressing the select button. Otherwise select from an appropriate list of units for the parameter type.

**Precision** Select the number of digits following the decimal point to display. This should be appropriate for the measurement. Options are 0 to 5.

**Offline Value** This is the value reported by the parameter when in ‘Offline’ mode, for example, if the sensor is in alarm. Options are within the range of the parameter.

**Averaging** Enables or disables a rolling average for the parameter to smooth the reading. Options are “Enabled” or “Disabled”. Selecting “Enabled” will allow editing of the following two form fields.

**Length** Enter the number of data points in the rolling average buffer. Options are 2..60.

**Delay** Enter the delay between collecting data points for the rolling average<sup>2</sup>. Options are 200..5000ms.

### 3.1.6.6 Oxygen Saturation

Parameter settings are accessed by selecting:

Options → Setup → Oxygen Saturation

The screenshot shows a 'Parameter Setup' window with the following fields and values:

- Type: Oxygen Saturation (dropdown menu)
- Precision: 1 (spin box) Digits
- Units: % (dropdown menu)
- Offline Value: 0.0 (text input)
- Averaging: Disabled (radio button selected)
- Length: 60 (spin box)
- Delay: 0500 (spin box) ms

At the bottom of the window are two buttons: 'Home' and 'Options'.

**Type** A selectable list of parameter types. The selection made here will affect what options are available below.

**Name** Available if “User defined” is selected as the type. The name can be up to 25 characters.

**Units** If “User defined” is selected above, set the units using the custom units’ entry screen that will be displayed when pressing the select button. Otherwise select from an appropriate list of units for the parameter type.

**Precision** Select the number of digits following the decimal point to display. This should be appropriate for the measurement. Options are 0 to 5.

**Offline Value** This is the value reported by the parameter when in ‘Offline’ mode, for example, if the sensor is in alarm. Options are within the range of the parameter.

**Averaging** Enables or disables a rolling average for the parameter to smooth the reading. Options are “Enabled” or “Disabled”. Selecting “Enabled” will allow editing of the following two form fields.

**Length** Enter the number of data points in the rolling average buffer. Options are 2..60.

**Delay** Enter the delay between collecting data points for the rolling average<sup>3</sup>. Options are 200..5000ms.

<sup>2</sup>An averaging delay of 2000ms with a length of 30 will result in a rolling average of 1 minute (30 × 2s) with a reading taken every 2 seconds. If averaging is enabled it will apply to all aspects of the parameter value, e.g., it will apply to the value displayed, logged and outputted.

<sup>3</sup>An averaging delay of 2000ms with a length of 30 will result in a rolling average of 1 minute (30 × 2s) with a reading taken every 2 seconds. If averaging is enabled it will apply to all aspects of the parameter value, e.g., it will apply to the value displayed, logged and outputted.

### 3.1.6.7 Oxygen Partial Pressure

Parameter settings are accessed by selecting:

Options → Setup → Oxygen Partial Pressure

The screenshot shows a 'Parameter Setup' window. At the top, the title is 'Parameter Setup'. Below the title, there is a dropdown menu for 'Type' with 'Oxygen Partial Pressure' selected. Underneath, there are two rows of controls: 'Precision' with a spinner set to '1' and the label 'Digits', and 'Units' with a dropdown menu set to 'Torr'. The next row has 'Offline Value' with a text input field containing '0.0'. The final row has 'Averaging' with two radio buttons, 'Enabled' (unselected) and 'Disabled' (selected), 'Length' with a spinner set to '60', and 'Delay' with a spinner set to '0500' and the unit 'ms'. At the bottom of the window are two buttons: 'Home' and 'Options'.

**Type** A selectable list of parameter types. The selection made here will affect what options are available below.

**Name** Available if “User defined” is selected as the type. The name can be up to 25 characters.

**Units** If “User defined” is selected above, set the units using the custom units’ entry screen that will be displayed when pressing the select button. Otherwise select from an appropriate list of units for the parameter type.

**Precision** Select the number of digits following the decimal point to display. This should be appropriate for the measurement. Options are 0 to 5.

**Offline Value** This is the value reported by the parameter when in ‘Offline’ mode, for example, if the sensor is in alarm. Options are within the range of the parameter.

**Averaging** Enables or disables a rolling average for the parameter to smooth the reading. Options are “Enabled” or “Disabled”. Selecting “Enabled” will allow editing of the following two form fields.

**Length** Enter the number of data points in the rolling average buffer. Options are 2..60.

**Delay** Enter the delay between collecting data points for the rolling average<sup>4</sup>. Options are 200..5000ms.

### 3.1.6.8 Alarms and Thresholds

Alarms are the means by which values obtained from sensors cause visible, audible or physical actions to occur. Alarms are not to be confused with relays. An alarm in a HydroAct 4 unit will create a visible bar across the top of the screen and sound a buzzer. One flow alarm per sensor and two data alarms per parameter are available.

Thresholds are similar to alarms except that they are events that are supposed to occur and therefore will not cause the instrument to go into “Alarm”. Thresholds are most frequently used to trigger relays to cause something to happen when a parameter reaches a value.

To access the alarm and threshold configuration select:

Options → Alarms & Thresholds → *Parameter Name*

The display has a tab for each alarm and threshold. Navigate to the tab using the right and left buttons indicated on the bottom of the display or navigate through the settings using the up and down arrows. Options are:

**Enabled** Selecting this option turns the alarm/threshold on or off.

<sup>4</sup>An averaging delay of 2000ms with a length of 30 will result in a rolling average of 1 minute (30 × 2s) with a reading taken every 2 seconds. If averaging is enabled it will apply to all aspects of the parameter value, e.g., it will apply to the value displayed, logged and outputted.

**Set** The *Value* is used to trigger the alarm or threshold<sup>5</sup>. The *Delay* is the amount of time the value has to exceed the set value before the alarm/threshold is triggered.

**Reset** The *Value* is used to clear the alarm or threshold. The *Delay* is the amount of time the value has to exceed the reset value before the alarm/threshold is cleared.

### 3.1.6.9 Maintenance Setup

The Dissolved Oxygen Sensor comes equipped with proactive maintenance alerts. These take the form of a calibration warning. In effect the user determines how long after the calibration event occurs they would like to be reminded that the next calibration is due again. When an alert occurs, the color of the parameter display will change and a parameter flag is set.

The maintenance requirements can be enabled or disabled and frequencies entered into simple forms. To configure the maintenance warnings, select:

Options → Maintenance → Setup

**Maintenance Setup**

Calibration Warning  Enabled      Frequency 30      Days

Last Calibration: Never

Home      Options

### 3.1.6.10 Calibration

The calibration procedure is described in section 3.1.5.

### 3.1.6.11 Advanced Calibration

To view or manually modify the calibration, select:

Options → Maintenance → Advanced

**Advanced Calibration**

Slope  (0.85 .. 1.20)

Offset  (-0.200 .. 0.200)

Home      Options      Reset

**Slope** Modifier to the calibration slope. Default is 1.00, with available options 0.85..1.20.

**Offset** Calibration offset. Default is 0.000, with available options  $\pm 0.200$ .

<sup>5</sup>A set value above a reset value will result in a rising alarm. A set value below a reset value will result in a falling alarm.

### 3.1.6.12 Status Flags

The status flags show the state of a device. These flags can either be active or not. To see the state of these status flags, select:

Options → Device Flags → Status Flags

Flags that are active are shown in black text on a white background, those that are not active are grayed out. Available flags are:

**Display on main menu** When active the device tile is displayed on the main menu. If inactive, the tile is hidden in the default view.

**Sensor enabled** This flag is enabled if the sensor is enabled.

**Sensor on-line** This flag is enabled if the sensor is on-line.

**Sensor reading in warm up** If the sensor reports that the current reading is not ready, then this flag is set.

**Sensor reading in hold** This flag is enabled when the sensor output value is held, usually during, or just after, self-cleaning or periods of maintenance.

**Sensor process stopped** If the sensor is off-line due to a process stop signal, this flag is set.

**Sensor flush active** This flag is set when the sensor is self-cleaning.

**Sensor calibration warning reached** If the calibration is due and the maintenance warning is enabled, then this flag is set

**Sensor maintenance period x warning reached** If the maintenance warning is enabled and the due date has passed, then this flag is set. The exact type of maintenance is sensor-specific. See section 3.1.6.9 for details.

### 3.1.6.13 Error Flags

The error flags show any problems causing an error for a device. These flags can either be active or not. To see the state of these error flags, select:

Options → Device Flags → Error Flags

Flags that are active are shown in black text on a white background, those that are not active are grayed out. Available flags are:

**I/O card fault detected** If set, this flag indicates that a low-level hardware fault has occurred. Report to your supplier.

**Incorrect I/O card found** If set, this flag indicates that the I/O card fitted is of the wrong type.

**I/O card in use** This flag is set when two devices are attempting to use the same I/O card.

**Sensor connection error** This flag is set when the sensor hardware detects a physical connection fault.

**Sensor failed to read input signal** If set, the sensor has failed to read the state of the flow, flush or process signal.

**Sensor flow alarm active** This flag is set if a low/no flow condition is reported by the flow signal.

**Sensor data alarm active** When the sensor readings trigger a data alarm, this flag is set.

**I/O card configuration failed** This flag is set if the I/O plugin card fails to respond correctly. Contact your supplier for advice.

**Modbus communications error** This flag is set when a Modbus exception, timeout or checksum failure occurs. If clear, communication with the sensor is normal.

**Device identifier mismatch** If set, this flag indicates that the sensor connected to the Modbus input is not responding as expected. Check that the correct sensor is connected.

**Sensor malfunction** If set, this flag indicates that the Dissolved Oxygen Sensor sensor is reporting a malfunction with the sensor cap.

**Device malfunction** If set, this flag indicates that the Dissolved Oxygen Sensor sensor is reporting a malfunction with the sensor electronics.



**Sensor cap is missing** This flag is set when the sensor cap is missing or has not been connected properly.

**Sensor cap has expired** This flag indicates that the sensor cap has expired and no longer functions.

**Sensor cap error** If set, this flag indicates that the sensor cap is damaged.

**Sensor verification failed** This flag is set when the automatic verification feature (if enabled) fails to detect the correct response from the sensor during a cleaning cycle.

#### 3.1.6.14 Parameter Flags

The parameter flags show the state of an individual parameter of a particular sensor. These flags can either be active or not. To see the state of these parameter flags, select:

Options → Device Flags → *Parameter Name*

Flags that are active are shown in black text on a white background, those that are not active are grayed out. Available flags are:

**Alarm 1 active** The first parameter data alarm is active and triggered.

**Alarm 2 active** The second parameter data alarm is active and triggered.

**Averaging enabled** The value displayed for this parameter is averaged.

**Threshold 1 active** The first parameter threshold is active and triggered.

**Threshold 2 active** The second parameter threshold is active and triggered.

#### 3.1.6.15 Sensor Information

To access sensor information, select:

Options → Diagnostics → Sensor Information

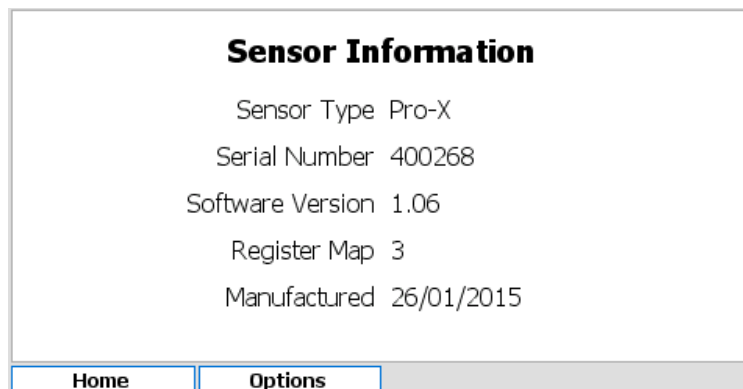

This screen shows information for the main sensor electronics. For information about the replaceable sensor cap, see below.

#### 3.1.6.16 Sensor Cap Information

To access information regarding the sensor cap, select:

Options → Diagnostics → Sensor Cap Information

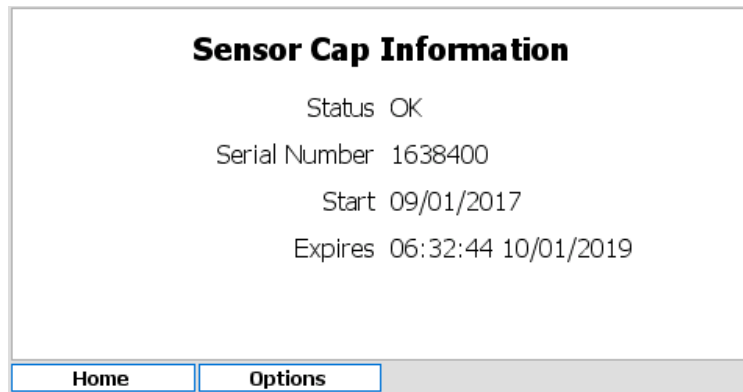

**Status** Shows the current status of the sensor cap. The message will reflect any issues with the cap, such as expired, damaged or missing caps.

**Serial Number** Displays the serial number of the sensor cap. This information may be needed for technical support queries.

**Start** Shows the date the cap was first used. This starts the cap expiration timer.

**Expires** Shows the date and time the cap will expire and should be replaced prior to this date.

### 3.1.6.17 Modbus Statistics

To access the Modbus statistics diagnostic information, select:

Options → Diagnostics → Modbus Statistics

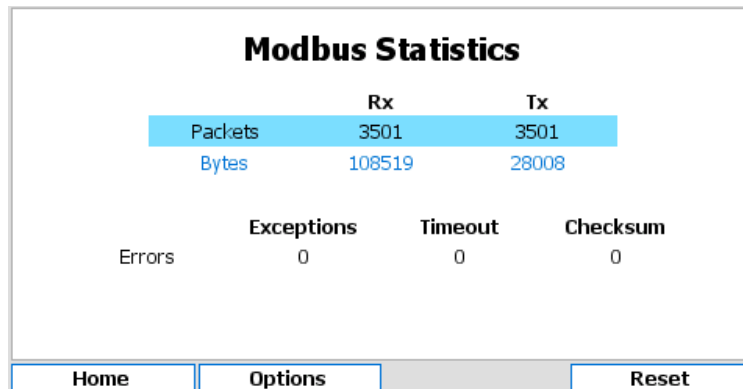

Received and transmitted byte and packet counts are displayed along with error counters. Error counters for packets received with checksum errors, timeouts and exception packets generated are recorded. Counters are unsigned 32-bit and will overflow back to 0 if they reach 4,294,967,295. Alternatively, all counters can be manually reset by pressing the “Reset” button.

### 3.1.6.18 Connections

As the HydroAct 4 is a modular system the exact wiring details will be specific to each order. Electrical connections required can be viewed by selecting:

Options → Connections

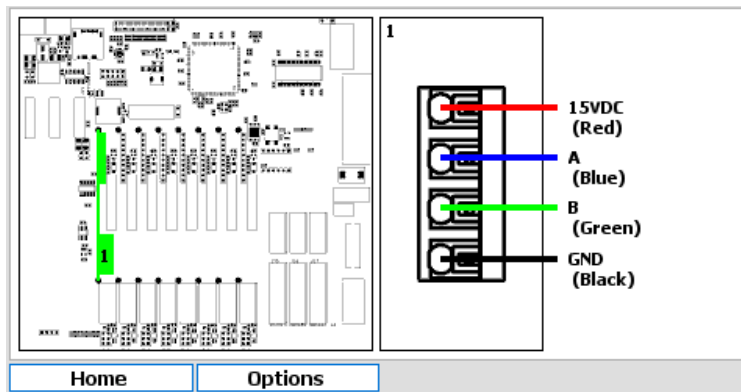

In the image above, the left side shows the position of the connector. The right side shows the connections required on the marked connectors.

**Disconnect the power before making or breaking electrical connections.**

### 3.1.7 Maintenance

**To avoid damaging the sensor, please take notice of the following instructions.**

- The sensor cap must be pulled off the sensor tip and not twisted off.
- Do not touch or clean the lens with anything other than the lens wipe supplied.
- Do not transfer grease to the gold pins or lens.
- The O-rings must not be pinched or rolled between the sensor cap and sensor.
- Do not use organic solvents as this will damage the sensing foil on the sensor cap. Do not remove the cap from the sensor prior to cleaning.

#### 3.1.7.1 Changing the sensor cap

The sensor cap will require changing at least every two years but may need changing sooner if you are experiencing difficulties calibrating, i.e., sensor is displaying unstable readings or values that are too low.



Unscrew the sensor nose cone or auto-clean nose cone in a dust-free environment. Pull the used sensor cap off of the sensor, without twisting. Remove the existing O-rings from the sensor and use a lint-free cloth to remove any moisture from the sensor body.

**There must be no moisture in the O-ring grooves. Do NOT touch or clean the lens with anything other than the lens wipe supplied.**



Apply a thin coat of lubricant around the O-ring grooves, fit 2 new O-rings into the grooves and then apply another thin coat of lubricant to the O-rings and grooves. With the wipe provided, clean the lens and allow to dry thoroughly. Inspect for scratches and dirt.

**Take great care not to transfer grease to the lens or pins.**



Remove the sensor cap from its sealed packaging and insert onto the sensor tip, being careful to press firmly, without twisting, until it seals over the sensor tip. Replace the nose cone and perform a 1 or 2 point calibration, see section 3.1.5.

### 3.1.7.2 Cleaning the sensor

Leaving the sensor cap and nose cone in position on the sensor body, rinse the sensor with clean water, preferably from a squirt bottle or spray bottle. Gently wipe the sensor clean with a soft-bristled brush or soft cloth if biofouling is present. Use lens wipe to remove grease. If extensive fouling or mineral build up is present, soak the cap end of the sensor in vinegar for approx 15 mins, then soak in de-ionized water for 15 mins.

**Do not use organic solvents as this will damage the sensing foil. Do not remove the cap from the sensor prior to brushing.**

After cleaning perform a calibration, see Section 3.1.5 for details.

### 3.1.7.3 Cleaning the lens

- Clean the lens only when changing the sensor cap.
- Do not wet the lens area with water or any solution.
- Remove the sensor cap as described in Section 3.1.7.1 cap and gently wipe the lens with the supplied lens wipe.
- Use only the supplied lens wipe for cleaning.

### 3.1.7.4 Replacing the sensor body O-ring



Remove the sensor nose cone and remove the old O-ring. Clean the O-ring groove with a lint free cloth to ensure the groove is free from dirt. Place a small amount of lubricant on your fingertips and coat the entire new O-ring with lubricant, being careful not to allow any dust or particles to get on the new O-ring. Place the new O-ring on the sensor body. Use the lens wipe to remove any lubricant from the sensor body or sensor cap. Place the nose on the sensor body.

**3.1.7.5 Cap storage**

Prior to installation the sensor cap must be stored in the factory supplied container. If storage is required after initial installation store the complete sensor in the calibration chamber with the sensor cap and nose cone attached. Place a few drops of clean water in the bottom of the calibration chamber.

**Ensure that the storage cap (no vent hole) for the calibration chamber is used and not the calibration cap.**

**3.1.8 Troubleshooting****3.1.8.1 Sensor Error reported**

Possible cause	Possible solution
Sensor disconnected.	Check sensor connections.
Sensor connected incorrectly.	Check sensor is connected to the correct channel.

**3.1.8.2 Dissolved oxygen reading is incorrect**

Possible cause	Possible solution
Calibration error	Recalibrate span.
Zero error.	Recalibrate zero.

**3.1.8.3 Dissolved oxygen reading is too high**

Possible cause	Possible solution
Strong oxidizer (sodium permanganate or potassium permanganate).	Remove oxidizers from system.

**3.1.8.4 Damaged foil or cap**

Possible cause	Possible solution
Hydrogen peroxide (e.g. 3%) or bleach (above 2%).	Replace cap.

**3.1.8.5 Erratic dissolved oxygen readings**

Possible cause	Possible solution
Incorrect installation.	Ensure probe is installed at an angle and if auto-clean cap is installed ensure the orientation is correct. See section 3.1.3



## 4. Controls

### 4.1 PID Control

#### 4.1.1 General Information

##### 4.1.1.1 Theory of Operation

The PID control calculates an error value as the difference between a desired setpoint and a measured sensor input, called the process variable. The control then calculates an output using this error value based on proportional, integral and derivative terms. The output of these terms is combined to give a final output.

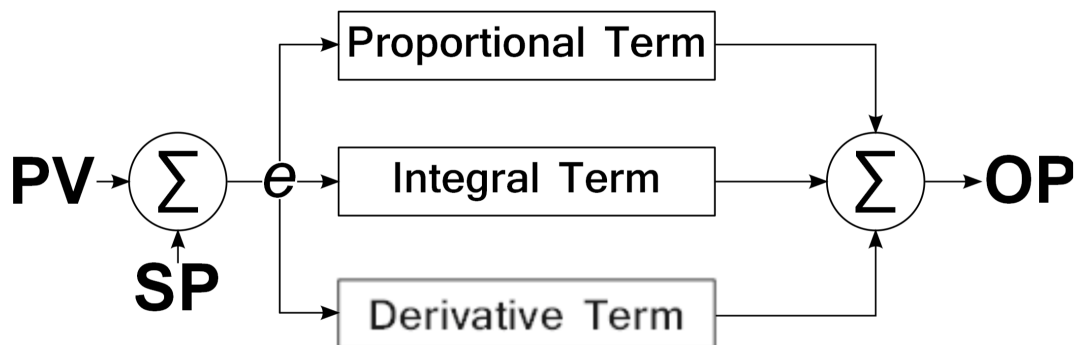

Figure 4.1: PID Calculation

The PID implementation of the HydroAct 4 is very flexible and can be configured as any permutation of P, I and D. This allows P, I, PI, PD or PID controllers to be implemented using the same interface. The optimal control response for any application requires the correct selection of control components. Some examples are given below.

**P Controller** A simple linear control algorithm ideally suited to recirculating systems with small deviations such as those found in pools and spas. Major deviations may result in an overshoot

and control offsets are to be expected. Control offsets in a purely proportional system are referred to as proportional droop. Offsets occur in systems where there is an opposing process affecting the process variable. For example, chlorine will evaporate from a pool surface. When the rate of loss is equal to the rate of chlorine addition then a steady state will be achieved. This equilibrium point will be at a chlorine concentration below the set point. A dosing pump being controlled by a P controller will be slightly off when the setpoint is reached.

**PI Controller** Integral action enables PI controllers to eliminate offset, which is a major weakness of a P controller. PI controllers provide a balance of complexity and capability that makes them by far the most widely used algorithm in process control applications. A dosing pump controlled by a PI controller will still be pumping when the setpoint is reached.

**PD Controller** PD control is useful for fast response controllers that can tolerate, or are not affected by, a control offset. Derivative action acts on the rate of change of the process variable error. This provides a fast response but is susceptible to measurement noise. PD controllers can be useful in applications where overshoot can not be tolerated, such as batch pH neutralization.

**PID Controller** Used in applications where control provided by other permutations of P, I and D actions are inadequate. The PID controller calculates an error value between a measured process variable and a desired setpoint. The calculated error is used in three separate calculations that calculate an output proportional to the error (the proportional term), an output proportional to the magnitude and duration of the error (the integral term) and an output proportional to the rate of change of the error (derivative term). The PID controller output is the sum of the three constituent terms as shown in figure 4.1. The result is in the form a decimal fraction<sup>1</sup> that is converted to a percentage for control output.

#### 4.1.1.1.1 Proportional Term

The proportional term produces an output value that is proportional to the current error value. The proportional response can be adjusted by multiplying the error by the proportional gain, adjustable in the PID configuration.

$$P_{out} = K_p \cdot e$$

where  $P_{out}$  is the proportional term output,  $K_p$  is the proportional gain and  $e$  is the error.

A large proportional gain value gives a large change in the output for a given change in the error. If the proportional gain is too high, the system can become unstable and overshoot will occur. Too small a gain value results in a small output response to a large input error, and a less responsive controller. If the proportional gain is too low, the control action may be too small when responding to system disturbances and may not achieve a setpoint.

#### 4.1.1.1.2 Integral term

The Integral term is proportional to both the magnitude of the error and the duration of the error. The integral in a PID controller is the sum of all the measured error over time and gives the accumulated offset that should have been corrected previously. The accumulated error is then multiplied by the integral gain, adjustable in the PID configuration.

$$I_{out(t)} = I_{out(t-1)} + K_i \cdot e$$

where  $I_{out}$  is the integral term output,  $K_i$  is the integral gain and  $e$  is the error.

The integral term accelerates the movement of the process towards setpoint and eliminates the residual steady state error that occurs with a pure proportional controller. However, since the integral term responds to accumulated errors from the past, it can cause the present value to overshoot the setpoint value.

<sup>1</sup> Value is in the range 0..1, where 1 is equivalent to 100%



#### 4.1.1.1.3 Derivative Term

The derivative term is calculated by determining the slope of the error over time and multiplying this rate of change by the derivative gain, adjustable in the PID configuration.

$$D_{out} = K_d \left[ \frac{e - p}{\delta t} \right]$$

where  $D_{out}$  is the derivative term output,  $K_d$  is the derivative gain,  $\delta t$  is the loop time,  $e$  is the error and  $p$  is the previous error.

The derivative term slows the rate of change of the process variable. Derivative control is used to reduce the magnitude of the overshoot produced by the integral component and improve the process stability. However, the derivative term is susceptible to noise in the process variable signal and can result in an unstable system if the noise is too high.

### 4.1.2 Operation

When selecting the PID control tile from the main menu of the HydroAct 4, the control overview tile will be displayed.

**PID Controller 1.1 Overview**

PV: Free Chlorine Sensor 1.1 - Free Chlorine  
Target: 2.00mg/l

0.0<sup>Running</sup>%

Run Mode: Automatic

Manual Value: 0.0 %

Setpoint: 2.00 mg/l

Home Options Boost

The overview display of the PID controller is designed to allow the user to see the output and key information, and also be able to see key actions without having to enter the setup of the PID. Information shown includes the process variable, the target setpoint, the controller output and its operational mode. Options available for user input are:

**Run Mode** Options include: “Off”, “Manual”, “Automatic”.

**Manual Value** Sets the output when in manual mode. Options are between 0.00%..100.00%.

**Setpoint** Edit the setpoint within the range of the process variable.

Also on the display is a “Boost” button, if it is enabled. This engages the “Boost” function. See section 4.1.2.6 for details. If the control is in fail mode due to an error, the “Reset” button will be available to restart the control.

The following sections describe the functionality found in the pop-up menu that appears when pressing “Options”.

#### 4.1.2.1 Control Setup

This control is configured via the user interface of the HydroAct 4. To access the configuration, log in with advanced privileges and select:

Options → Setup → Control Setup

**Name** Enter the device name used to identify the control on the menu tiles, alarm messages etc. The name can be up to 25 characters.

**Display** Setting used to determine if device tile is shown on default main menu screen. Options are “Show” or “Hide”

**Enabled** Select whether to enable or disable the control device.

**Process Signal** Select whether to use a signal input to control the device process run/stop state. Controls in process stop are inhibited or paused. Options are “Disabled” or choice from a list of signal inputs.

**Start Delay** If a control is enabled and not in a process stop state, it can be in one of three states; started, running or fail. If a start delay is set, when a control is enabled or comes out of a process stop, it enters the mode specified by the start mode below. After the start delay has elapsed the control will automatically move into the run mode. The time specified is in HH:MM:SS.

**Start Mode** Select the start mode if a start delay is specified. Options are “Off”, “Manual” or “Automatic”.

**Run Mode** Select the run mode. Options are "Off", "Manual" or "Automatic".

**Fail Mode** If an error occurs the control will enter an alarm state and switch to the mode selected here. Options are “Off” or “Manual”.

#### 4.1.2.2 Process Variable

This variable is configured via the user interface of the HydroAct 4. To access the configuration go to:

Options → Setup → Process Variable

Options to select the control process variable are:

**Sensor** Select from a list of sensors.

**Parameter** Select from a list of parameters.

**Update delay** Update delay is the frequency that the feedback loop updates its output. The value is in HH:MM:SS format. The maximum update delay is 24 hours.

#### 4.1.2.3 Output Setup

The output is configured via the user interface of the HydroAct 4. To access the configuration go to:

Options → Setup → Output Setup

**Manual Value** Set the manual output value. The control output is set to this value if “Manual” is selected above. If the control has multiple output values, further tabs are available to define the output for each value. Values from 0.00% to 100.00% for any of “Start”, “Run” or “Fail” Mode.

#### Output Limits<sup>2</sup>

**Minimum** Set minimum output. Values from 0..100%

**Maximum** Set maximum output. Values from 0..100%

#### 4.1.2.4 PID Setup

The analyzer breaks down the setup of the PID control loop into different screens accessed from the tabs at the top of the display. Navigate around the screen using the “←” and “→” buttons.

##### 4.1.2.4.1 Setpoint Tab

**Type** Select “Static” if setpoint value is to be specified via user interface or “Dynamic” if setpoint is set remotely via 4..20mA input (i.e., from a SCADA or PLC). If “Static” is selected enter the target setpoint value. If “Dynamic” is selected choose the input parameter from the drop down lists.

<sup>2</sup>Output limits allow the user to put minimum and maximum limits on the control algorithm.

**Ramping** Enable or disable setpoint ramping. Large step changes in process variable errors can produce excessive PID output movements that could result in large over or undershoot, particularly for controllers using the I or D terms. These step changes are likely when the controller is first switched on or if the setpoint is changed. Setpoint ramping gradually moves the setpoint from its current value, or current process variable reading when the controller is first turned on, to the target value. This avoids the discontinuity present in a simple step change.

**Ramping Factor** If ramping is enabled, set the ramping factor. Values from 0.00 to 1.00. A value of 0.00 will prevent the setpoint from ramping at all, while a value of 1.00 will effectively turn this feature off.

#### 4.1.2.4.2 PID Tuning Tab

**Action** Select “Direct” if dosing increases process variable value (e.g., sodium hypochlorite addition increases free chlorine reading), or “Reverse” if dosing decreases value (e.g., acid dosing decreases pH).

**Bumpless Transfer** Bumpless transfer is only applied when the controller is running. It will not operate during the start delay. Bumpless transfer is designed to allow smooth transitions between automatic and manual control modes. It avoids large changes in pump output when changing the control mode. Bumpless transfer from automatic to manual control sets the manual output value to the last calculated control output. For bumpless transfer from manual to automatic mode, some integral control must be used. The initial integral error is set so that the pump output is equal to the current manual value. The PID algorithm will then make appropriate changes to this value to achieve the setpoint.

**Scale Factor** Scaling factor applied to calculated error. For example, a scaling factor  $\times 1000.0$  will convert an ORP reading ( $\pm 2000\text{mV}$ ) into a  $-2.0..+2.0$  error range to which the proportional, integral and derivative functions are applied. Values from  $\times 0.1$  to  $\times 1000.0$ .

**Proportional** Sets the proportional gain. Values from 0.000 to 10,000.000. A value of 0.000 disables proportional control.

**Integral** Sets the integral gain. Values from 0.000 to 10,000.000. A value of 0.000 disables integral control.

**Derivative** Sets the derivative gain. Values from 0.000 to 10,000.000. A value of 0.000 disables derivative control.

#### 4.1.2.4.3 IWP Tab

Integral windup refers to the situation when the process variable spends a significant amount of time away from the setpoint. During this time the integral term accumulates a significant error (referred to as windup) and an overshoot occurs whilst the accumulated error is negated by errors in the opposite direction (the error is unwound). To prevent this excessive overshoot integral windup protection (IWP) limits the maximum windup, both positive and negative. Integral windup protection is only available if the integral gain is greater than 0 (i.e., there is an integral part to the control).

**Enabled** Enables the integral windup protection feature. Options are “Yes” or “No”.

**Minimum** The smallest accumulated error the integral term is allowed to wind up, usually negative or commonly zero. Values from -1000.00/% to +1000.00/%

**Maximum** The largest accumulated error that the integral term is allowed to windup, usually positive. Values from -1000.00/% to +1000.00/%

#### 4.1.2.4.4 Overfeed Protection Tab

Overfeed protection is designed to identify problems associated with dosing equipment. Blocked injectors, empty day tanks and dosing pump failures are likely causes to trigger this feature. This alarm may identify the problem before the detrimental effects of control loss are encountered. If the PID output is judged to be having no effect then the controller will enter the specified fail mode, log the event in the system log and sets off a control alarm. Manual intervention is required to rectify the fault and reset the PID controller by setting the desired run mode using the PID Setup or Overview screens.

**Enabled** This enables overfeed protection. If enabled the parameters below are available for configuration.

**Timeout** Time period in which the process variable must respond to dosing before overfeed protection activates. Values in HH:MM:SS

**Interval** Amount the process variable must move towards setpoint to reset the timeout timer set above.

**Deadband** Overfeed protection is disabled when process variable is within this value of setpoint.

#### 4.1.2.4.5 Boost Tab

Boost allows for a temporary secondary setpoint or a fixed control output. This can be used for shock dosing of a swimming pool or periodic increased dosing for additional disinfection of a bottle plant washer. When activated the boost function will either change the PID setpoint to the secondary value (usually higher) or set the control output to the selected level and will maintain it for a pre-determined time. It will then disable the function for a configurable period to prevent overuse.

**Enabled** Enables the boost feature and allows users to initiate the boost from the “Boost Status” option.

**Action** Options are “Output” or “Setpoint”. Selecting “Output” allows the user to set a pre-determined control output. Selecting “Setpoint” allows the user to set a new target for the PID control.

**Value** Set the new output value or target setpoint, based on the selection above.

**Duration** Set the duration of the boost. Value is in HH:MM:SS format, up to 24 hours.

**Delay** Set the inhibition delay, the time after a boost before a user can initiate a subsequent boost. Value is in HH:MM:SS format, up to 24 hours.

#### 4.1.2.4.6 Options Tab

**Fail-safe on PV Alarm.** If the process variable goes into data alarm the controller will go into fail-safe mode.

#### 4.1.2.5 Alarms and Thresholds

Alarms are the means by which values obtained from sensors cause visible, audible or physical action to occur. Alarms are not to be confused with relays<sup>3</sup>, as very flexible firmware and electronics are utilized. An alarm in a HydroAct 4 unit will be visible on the screen and sound a buzzer. Two output alarms per control output are available. Thresholds are similar to alarms except that they are events that are supposed to occur and therefore will not cause the instrument to go into “Alarm”. Thresholds are used to trigger relays to cause something to happen when a control output reaches a value.

To access the configuration:

Options → Alarms & Thresholds

<sup>3</sup>A mechanical or electronic device mounted on the electronics within the instrument that can switch (much like a light switch). The number and type of relays is specified at the time of order.

The display has a tab for each alarm and threshold. Navigate to the tab using the Right and Left buttons or through the settings using the Up and Down arrows.

**Options are:**

**Enabled** Selecting this option turns the alarm/threshold on or off.

**Set** The *Value* is used to trigger the alarm or threshold<sup>4</sup>. The *Delay* is the amount of time the value has to exceed the set value before the alarm/threshold is triggered.

**Delay** The amount of time the value has to exceed the set point before the alarm/threshold is triggered. HH:MM:SS up to 24 hours.

#### 4.1.2.6 Boost Status

Selecting this will show the user the status of the boost function including the delay controls. Access this information at:

Menu → Options → Boost Status

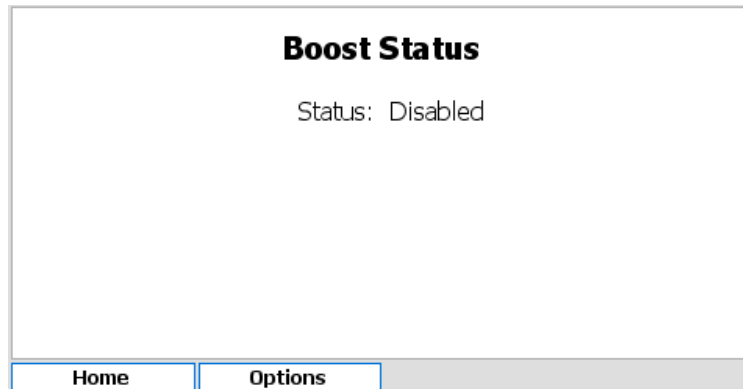

#### 4.1.2.7 Status Flags

The status flags show the state of a device. These flags can either be active or not. To see the state of these status flags, select:

Options → Device Flags → Status Flags

Flags that are active are shown in black text on a white background, those that are not active are grayed out. Available flags are:

**Display on main menu** When active the device tile is displayed on the main menu. If inactive, the tile is hidden in the default view.

**Control enabled** This flag is set if the control is enabled.

**Control process stopped** If this flag is set, the control is stopped due to the process run/stop signal state.

**Control started** This flag is set when the control is started, i.e., the control is either in start-up or run mode.

**Control running** This flag is set when the control is in run mode.

**Primary Output pump output limit reached** This flag is set when the primary output loop is limited by the pump minimum or maximum output settings.

**Secondary Output pump output limit reached** This flag is set when the secondary output loop (if used) is limited by the pump minimum or maximum output settings.

**Tertiary Output pump output limit reached** This flag is set when the tertiary output loop (if used) is limited by the pump minimum or maximum output settings.

<sup>4</sup>A set value above a reset value will result in a rising alarm. A set value below a reset value will result in a falling alarm.

**Loop Output threshold  $N$  active** If set, this flag indicates that the threshold  $N$  (where  $N$  is either 1 or 2) is active for the given output.

**Proportional control enabled** If set, this flag indicates that the proportional control is active in the current PID configuration.

**Integral control enabled** If set, this flag indicates that the integral control is active in the current PID configuration.

**Derivative control enabled** If set, this flag indicates that the derivative control is active in the current PID configuration.

**Bumpless transfer enabled** This flag is set when bumpless transfer is enabled.

**Integral wind-up protection enabled** This flag is set when integral wind-up protection is enabled.

**Integral wind-up protection active** If set, this flag indicates that integral wind-up protection is currently active.

**Boost enabled** This flag is set when the boost feature is enabled.

**Boost active** If set, this flag indicates the control is currently modified by the boost feature.

**Boost inhibited** This flag is set when the boost feature is inhibited from further activation.

#### 4.1.2.8 Error Flags

The error flags show any problems causing an error for a device. These flags can either be active or not. To see the state of these error flags, select:

Options → Device Flags → Error Flags

Flags that are active are shown in black text on a white background, those that are not active are grayed out. Available flags are:

**Process run/stop signal error** If set, this flag indicates that the control can not read the state of the run/stop signal.

**Process variable read error** This flag is set if the control can not read the process variable.

**Loop Output alarm  $N$  active** If set, this flag indicates that the alarm  $N$  (where  $N$  is either 1 or 2) is active for the given output. *Loop* is either primary, secondary or tertiary (most controls only have a primary output).

**Error reading PID setpoint** If set, this flag indicates the control is unable to read the setpoint value when using dynamic setpoints.

**Fail-safe mode active** This flag is set if the control enters failsafe mode.

**Overfeed protection active** This flag is set if over feed protection has been activated.

#### 4.1.2.9 Diagnostics

The PID controller diagnostic information can be accessed using:

Options → Diagnostics

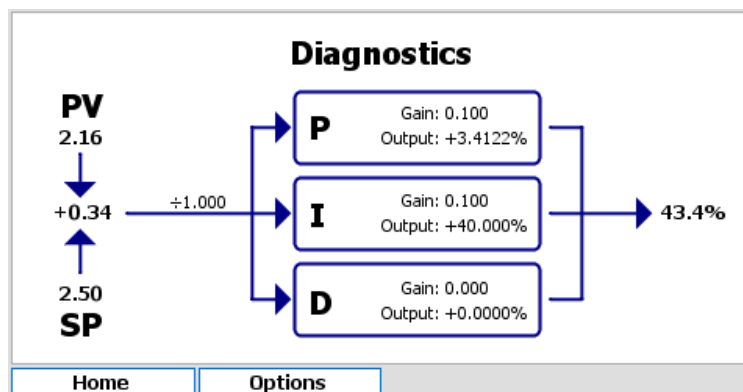



**Information displayed is only relevant if the control is in automatic mode.**

This display shows the diagram of the PID control and the current totalized PID output. For diagnostic information in automatic mode, the display is updated when the control loop is executed and there may be a delay equal to the loop time before all information is available. Process variable input (PV), and setpoint (SP) are shown pointing to the current error. The error feeds into each of the three P, I and D terms via the scale factor shown above the line. Each term shows the gain factor applied and the output calculated. These are summed together and trimmed within the set output limits to determine the control output.



## 5. Outputs

Outputs are the means by which values from measuring sensors, control outputs or system status are transmitted to another device. For example to a SCADA<sup>1</sup> for data acquisition or to a pump for dosing control. The two types of output used by HydroAct 4 are the analog output<sup>2</sup> and relay<sup>3</sup>.

In order to utilize the full capability of the instrument it is necessary to link the signal/value and an output device, such as an alarm, threshold or control options for the relays or analog outputs.

Chemtrac utilizes the latest in firmware and electronic innovations and as such analog outputs and relays are extremely flexible, and are not tied to individual sensors. In the past outputs were typically fixed to a specific sensor or control and the range was also the same as the range of the sensor. More recently the capability of the analog output to be more flexible has come about with advances in electronics.

### 5.1 Analog Outputs

#### 5.1.1 General Information

Analog outputs are typically a current output varying between 4mA and 20mA (although other options are available), and are proportional to a varying signal of interest generated by the instrument. Analog outputs are installed by plugging in a small output board into one of the available slots. Other output options in addition to 4..20 mA are shown below.

#### 5.1.2 Technical Data

**Supported modes** 0..20mA, 4..20mA, 0..1V, 0..10V, 1..10V

**Maximum voltage output** 15V DC (0/4..20mA only)

<sup>1</sup>Supervisory Control and Data Acquisition, a central data logging and control system

<sup>2</sup>A current or voltage output, proportional to a signal generated in the instrument

<sup>3</sup>A mechanical or electronic device mounted on the electronics within the instrument that can switch. The number and type of relays is specified at the time of order

### 5.1.3 Commissioning

When cables attach to analog outputs the instrument is forced to drive into different resistances. This can result in the analog range being slightly affected. For example a 4-20mA output at the analyzer could end up being 3.95mA to 19.9mA at the end of the cable. The HydroAct 4 has the capability to drive more or less current to account for this resistance so that the analog output is exactly that required at the end of the cable. This is achieved by calibrating the zero (offset) and span (top of the scale) of the analog output.

#### 5.1.3.1 Calibrate Offset

This configuration screen is accessed by navigating via the Options Menu:

Options → Maintenance → Calibrate Offset

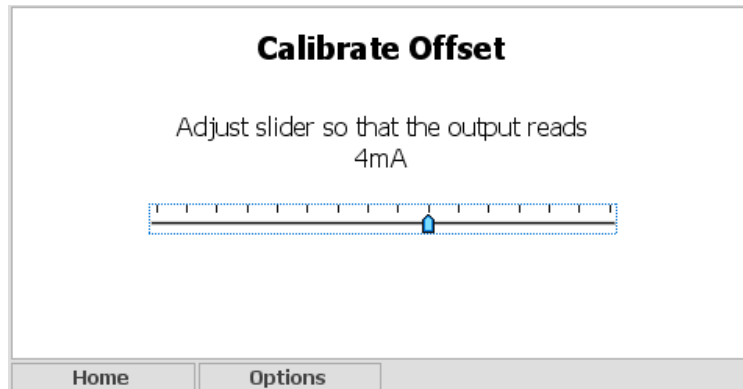

Select the slider and then use the Left and Right buttons to adjust the zero.

#### 5.1.3.2 Calibrate Span

This configuration screen is accessed by navigating via the Options Menu:

Options → Maintenance → Calibrate Span

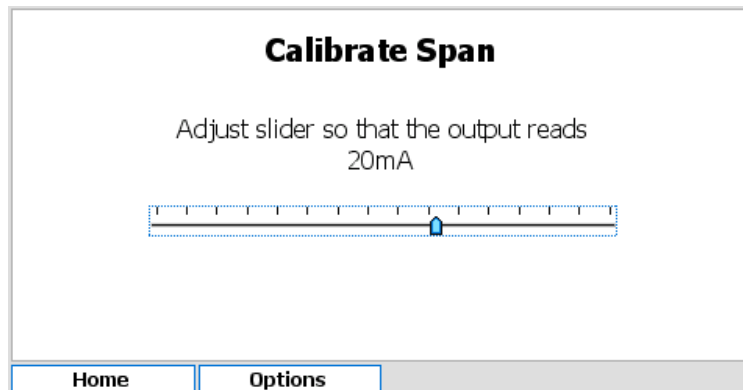

Select the slider and then use the Left and Right buttons to adjust the span.

### 5.1.4 Operation

To access the analog output setup and maintenance options, select the relevant device tile in the main menu and press “Select”. The output setup screen will be displayed initially, though other functions are available by pressing the “Options” button.

### 5.1.4.1 Setup

The setup of the analog output is split into three sections. Later sections can be accessed separately from the menu or by selecting “Next” from any of the previous pages. To access the analog output setup:

Options → Setup → Output Setup

**Name** Device name to identify the control in menus. Text can be up to 25 characters long.

**Display** Options are to “Show” or “Hide” the device tile on the menu screen.

**Enabled** Options are “Yes” or “No”.

**Mode Options** Options are “Manual” which allows the user to manually set an output value; “Data Output” which maps the output to an analog data source such as a parameter; and “Control Output” which maps the output to an analyzer generated control signal.

The “Next” button is a shortcut to the following configuration screen.

### 5.1.4.2 Options for Manual Mode

#### 5.1.4.2.1 Map Output

This configuration screen is accessed by pressing “Next” from the Output Setup configuration screen or navigating via the Options Menu.

Options → Setup → Map Output

#### 5.1.4.2.2 Configuration

This configuration screen is accessed by pressing “Next” from the Map Output above screen or navigating via the Options Menu.

Options → Setup → Configuration

**Configuration**

Type

Manual Value  %

**Type** Choose the type of analog output from the drop down box. See technical data for a list of supported output types. See section 5.1.2.

**Manual Value** Enter the manual value of the output as a percentage. For example if 4..20mA output type is selected a manual value of 50% will force the current output to 12mA.

### 5.1.4.3 Options for Data Output Mode

#### 5.1.4.3.1 Map Output

This configuration screen is accessed by pressing “Next” from the Output Setup screen or navigating via the Options Menu.

Options → Setup → Map Output

**Map Output**

Sensor

Parameter

**Sensor** Select the appropriate sensor from the drop down list.

**Parameter** Choose the appropriate parameter from the drop down list. If the selected sensor has only one parameter this option may not be available.

The “Next” button is a shortcut to the following configuration screen.

#### 5.1.4.3.2 Configuration Setup

This configuration screen is accessed by pressing “Next” from the Map Output screen or navigating via the Options Menu.

Options → Setup → Configuration

**Configuration**

Type

Minimum

Maximum

**Type** Choose the type of analog output from the drop down box. See the technical data in section 5.1.2 for a list of supported outputs.

**Minimum** Enter the parameter value that translates to a minimum output of e.g. 4mA if “type” is set to 4..20mA.

**Maximum** Enter the parameter value that translates to a maximum output of e.g. 20mA if “type” is set to 4..20mA.

The minimum and maximum values can be anywhere within the range of a parameter. For example the data output for a chlorine sensor with a range of 0..10ppm, the output could be ranged 0..10ppm (common) but could be ranged, for example 2.4..5.3ppm.

#### 5.1.4.4 Options for Control Output Mode

##### 5.1.4.4.1 Map Output

This configuration screen is accessed by pressing “Next” from the Output Setup screen or navigating via the Options Menu.

Options → Setup → Map Output

**Map Output**

Control

**Control** Select from a list of available control devices.

**Output** If the control selected above has more than one output value, this option will be available. Select the appropriate output value.

The “Next” button is a shortcut to the following configuration screen.

##### 5.1.4.4.2 Configuration

This configuration screen is accessed by pressing “Next” from the Map Output screen or navigating via the Options Menu.

Options → Setup → Configuration

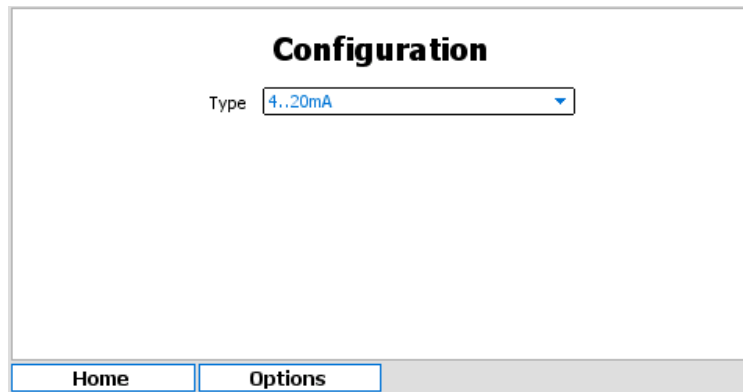

**Type** Choose the type of analog output from the drop down box. See the technical data in section 5.1.2 for a list of supported outputs.

#### 5.1.4.5 Status Flags

The status flags show the state of a device. These flags can either be active or not. To see the state of these status flags, select:

Options → Device Flags → Status Flags

Flags that are active are shown in black text on a white background, those that are not active are grayed out. Available flags are:

**Display on main menu** When active the device tile is displayed on the main menu. If inactive, the tile is hidden in the default view.

**Output calibrating offset** This flag is set when calibrating the analog output offset.

**Output calibrating span** This flag is set when calibrating the analog output span.

#### 5.1.4.6 Error Flags

The error flags show any problems causing an error for a device. These flags can either be active or not. To see the state of these error flags, select:

Options → Device Flags → Error Flags

Flags that are active are shown in black text on a white background, those that are not active are grayed out. Available flags are:

**Output mapping error** This indicates that one of the outputs is mapped incorrectly e.g., mapped to a sensor or control that no longer exists.

**I/O card fault detected** If set, this flag indicates that a low-level hardware fault has occurred. Report to Chemtrac.

**Incorrect I/O card found** If set, this flag indicates that the I/O card fitted is of the wrong type.

**I/O card in use** This flag is set when two devices are attempting to use the same I/O card.

**I/O card configuration failed** This flag is set if the I/O plugin card fails to respond correctly. Contact Chemtrac for advice.

#### 5.1.4.7 Connections

This screen is accessed by navigating via the Options Menu:

Options → Connections



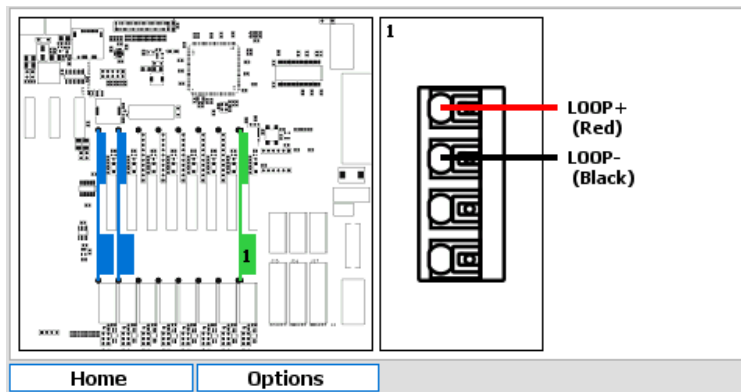

The image above is for an output with the types selected as 0..20mA or 4..20mA. The connections will reflect the configuration of the device and differ between current and voltage outputs.

## 5.2 Relay Output

### 5.2.1 General Information

Relay outputs, typically mechanical reed relays are installed at time of manufacture. A relay is a mechanical or electronic device mounted on the electronics within the instrument that can switch. The number and type of relays must be specified at time of order. In order to take advantage of the full capability of modern electronics, it is necessary to “map”<sup>4</sup> the various alarms, thresholds and other options to the relays.

### 5.2.2 Technical Data

**Maximum Current** 10A at 125 VAC, 3A at 250 VAC, 5A at 30 VDC

### 5.2.3 Operation

To access the relay output setup and maintenance options, select the relevant device tile in the main menu and press “Select”. The output setup screen will be displayed initially, though other functions are available by pressing the “Options” button.

#### 5.2.3.1 Setup

The setup of the analog output is split into three sections. Later sections can be accessed separately from the options or by selecting “Next” from any of the previous sections.

To access the relay output setup:

Options → Setup → Output Setup

<sup>4</sup>This describes the link between a signal/value generated by the instrument and an output device (relay or analog).

**Name** Device name to identify control in menus. Text can be up to 25 characters long.

**Display** Options are “Show” or “Hide” the device tile on the menu screen.

**Enabled** Options are “Yes” or “No”. This option must be enabled for the option to function.

**Mode Options** Options are “Manual” which sets a relay to manual output; “Control Output” which maps a relay to a control output and allows the setup of either pulse width modulation or pulse frequency modulation; “Data Output” which outputs a pulse for each set increment of a sensor parameter value; “Device Status Flags” which allows the mapping of a relay to activate if the status of a device changes; “Device Error Flags” which allows the mapping of a relay to activate if a device goes into error; “Parameter Flags” which allows the mapping of a relay to activate on selected parameter flags and “System Flags” which allows the mapping of a relay to activate on a system alarm state.

### 5.2.3.2 Options for Manual Mode

#### 5.2.3.2.1 Map Output

This configuration screen is accessed by pressing “Next” from the Output Setup configuration screen or navigating via the Options Menu.

Options → Setup → Map Output

The “Next” button is a shortcut to the following configuration screen.

#### 5.2.3.2.2 Configuration

This configuration screen is accessed by pressing “Next” from the Map Output screen or navigating via the Options Menu.

Options → Setup → Configuration

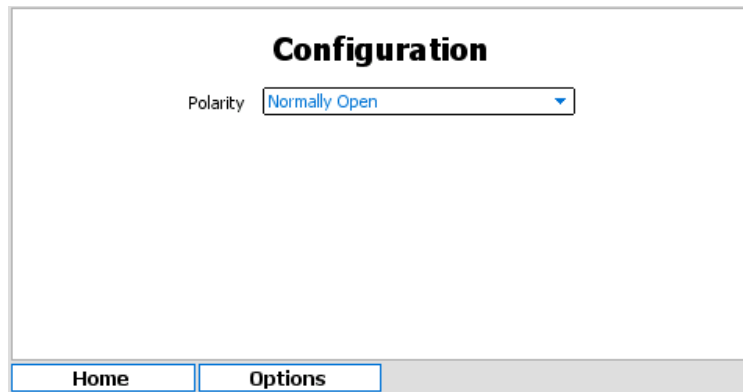

The screenshot shows a configuration window titled "Configuration". Inside the window, there is a label "Polarity" followed by a dropdown menu that currently displays "Normally Open". At the bottom of the window, there are two buttons: "Home" and "Options".

**Polarity** Options are “Normally Open” and “Normally Closed”.

### 5.2.3.3 Options for Control Output Mode

#### 5.2.3.3.1 Map Output

This configuration screen is accessed by pressing “Next” from the Output Setup configuration screen or navigating via the Options Menu.

Options → Setup → Map Output

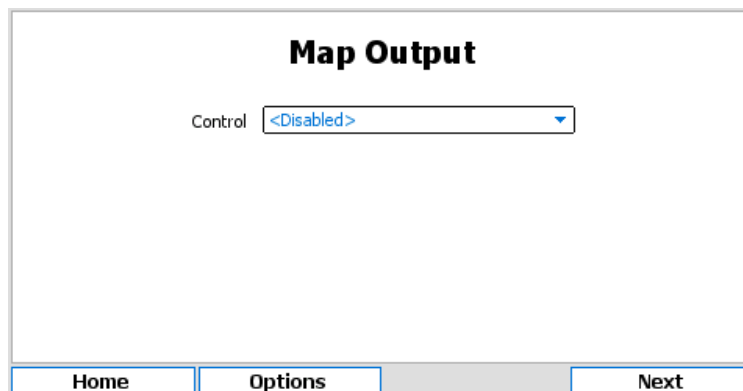

The screenshot shows a configuration window titled "Map Output". Inside the window, there is a label "Control" followed by a dropdown menu that currently displays "<Disabled>". At the bottom of the window, there are three buttons: "Home", "Options", and "Next".

**Control** Choose from a list of available controls to output the control value.

The “Next” button is a shortcut to the following configuration screen.

#### 5.2.3.3.2 Configuration

This configuration screen is accessed by pressing “Next” from the Map Output configuration screen or navigating via the Options Menu.

Options → Setup → Configuration

The screenshot shows a configuration window titled "Configuration". It contains the following settings:

- Polarity: Normally Open (dropdown menu)
- Mode: Pulse Width Modulation (dropdown menu)
- Pulse Width: 02 : 06 (two spinners)
- Deadband: 02 s (spinner)

At the bottom of the window are two buttons: "Home" and "Options".

In all cases the polarity and output mode of the relay will need to be configured. Pulse width modulation outputs a repeated pulse with a fixed width. The control signal is output by increasing the proportion of time the relay is active in any pulse as the value increases. Pulse frequency modulation outputs pulses of a fixed activated width, but increases the frequency of the pulses in respect of the control output value.

**Polarity** Options are "Normally Open" and "Normally Closed".

**Mode** Options are "Pulse Width Modulation" or "Pulse Frequency Modulation".

**When "Pulse Width Modulation" is selected further options are:**

**Pulse Width** Define the maximum pulse width in MM:SS. The relay will energize for a proportion of this time based on the control output value.

**Deadband** Defines the minimum pulse width that would be output. This can be used to avoid relay chatter due to a small control output value.

The screenshot shows a configuration window titled "Configuration". It contains the following settings:

- Polarity: Normally Open (dropdown menu)
- Mode: Pulse Frequency Modulation (dropdown menu)
- Pulse Width: 0000 ms (spinner)
- Maximum Frequency: 0.00 Hz (spinner)

At the bottom of the window are two buttons: "Home" and "Options".

**When "Pulse Frequency Modulation" is selected further options are:**

**Pulse Width** Define the length of pulses output. Options are between 0..5000 ms.

**Maximum Frequency** As the control output value increases, the frequency of pulses outputs increase. This setting defines the maximum frequency of pulse outputs.

#### 5.2.3.4 Options for Data Output Mode

##### 5.2.3.4.1 Map Output

This configuration screen is accessed by pressing "Next" from the Output Setup screen or navigating via the Options Menu.

Options → Setup → Map Output

**Map Output**

Sensor

Parameter

**Sensor** Select the appropriate sensor from the drop down list.

**Parameter** Choose the appropriate parameter from the drop down list. If the selected sensor has only one parameter this option may not be available.

The “Next” button is a shortcut to the following configuration screen.

#### 5.2.3.4.2 Configuration Setup

This configuration screen is accessed by pressing “Next” from the Map Output screen or navigating via the Options Menu.

Options → Setup → Configuration

**Configuration**

Polarity

Frequency  m<sup>3</sup>

Pulse Width  ms

Pulse Gap  ms

**Polarity** Options are “Normally Open” and “Normally Closed”.

**Frequency** Set the pulse frequency as a desired increase in parameter value.

**Pulse Width** Set the pulse width. The values are in milliseconds and increment in steps of 200ms.

**Pulse Gap** Set the minimum pulse gap. The values are in milliseconds and increment in steps of 200ms.

#### 5.2.3.5 Options for Device Status Flags

##### 5.2.3.5.1 Map Output

This configuration screen is accessed by pressing “Next” from the Output Setup configuration screen or navigating via the Options Menu.

Options → Setup → Map Output

**Map Output**

Device

**Device** Choose from a list of available devices.

The “Next” button is a shortcut to the following configuration screen.

#### 5.2.3.5.2 Configuration

This configuration screen is accessed by pressing “Next” from the Map Output configuration screen or navigating via the Options Menu.

Options → Setup → Configuration

**Configuration**

Polarity

Mode

Pulse Width  :

Deadband  s

**Polarity** Options are “Normally Open” and “Normally Closed”. The device status flags available depend on the device mapped above. See the status flag descriptions for that device for details.

Press the “Next” button to select the device status flags used to activate the relay.

#### 5.2.3.6 Options for Device Error Flags

##### 5.2.3.6.1 Map Output

This configuration screen is accessed by pressing “Next” from the Output Setup screen or navigating via the Options Menu.

Options → Setup → Map Output

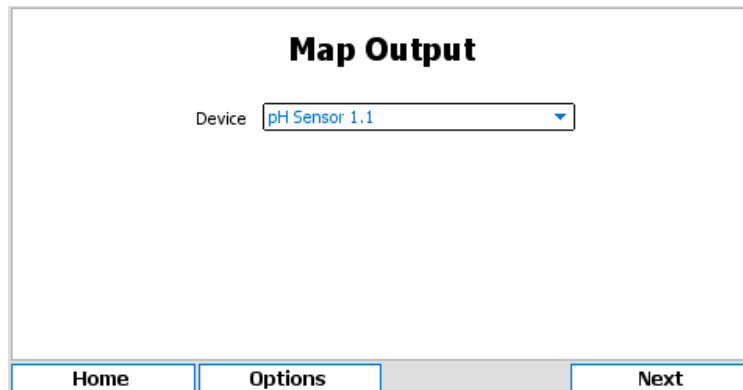

**Map Output**

Device

Home Options Next

**Device** Choose from a list of available devices.

The “Next” button is a shortcut to the following configuration screen.

#### 5.2.3.6.2 Configuration

This configuration screen is accessed by pressing “Next” from the Map Output screen or navigating via the Options Menu.

Options → Setup → Map Configuration

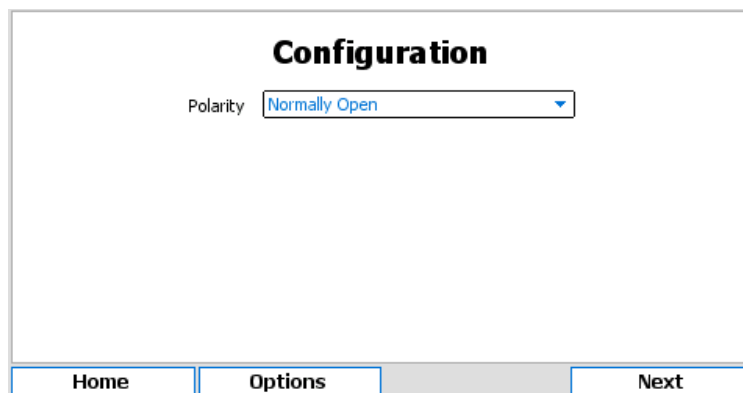

**Configuration**

Polarity

Home Options Next

**Polarity** Options are “Normally Open” and “Normally Closed”. The device error flags available will depend on the device mapped above. See that device description for details.

Press the “Next” button to select the device error flags used to activate the relay.

#### 5.2.3.7 Options for Parameter Flags

##### 5.2.3.7.1 Map Output

This configuration screen is accessed by pressing “Next” from the Output Setup screen or navigating via the Options Menu.

Options → Setup → Map Output

**Map Output**

Sensor

Parameter

**Sensor** Choose the appropriate sensor from the drop down list.

**Parameter** Choose the appropriate parameter from the drop down list.

The “Next” button is a shortcut to the following configuration screen.

#### 5.2.3.7.2 Configuration

This configuration screen is accessed by pressing “Next” from the Map Output screen or navigating via the Options Menu.

Options → Setup → Configuration

**Configuration**

Polarity

**Polarity** Options are “Normally Open” and “Normally Closed”.

The “Next” button is a shortcut to the following configuration screen.

#### 5.2.3.7.3 Relay Selection

This configuration screen is accessed by pressing “Next” from the Configuration screen.

**Relay 1.1**

Flag Selection

Alarm 1 active

Alarm 2 active

Averaging enabled

Threshold 1 active

Threshold 2 active



Flags that are active are shown in black text on a white background, those that are not active are grayed out. Selecting the flag will cause the relay to activate if that parameter flag becomes active.

### 5.2.3.8 Options for System Status

#### 5.2.3.8.1 Map Output

This configuration screen is accessed by pressing “Next” from the Output Setup configuration screen or navigating via the Options Menu.

Options → Setup → Map Output

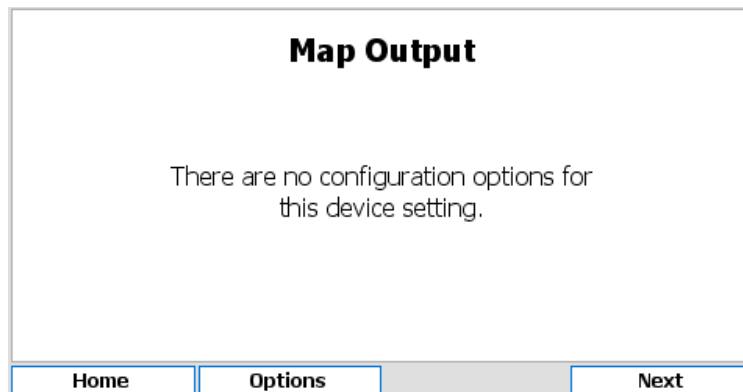

#### 5.2.3.8.2 Configuration

This configuration screen is accessed by pressing “Next” from the Output Setup configuration or navigating via the Options Menu.

Options → Setup → Configuration

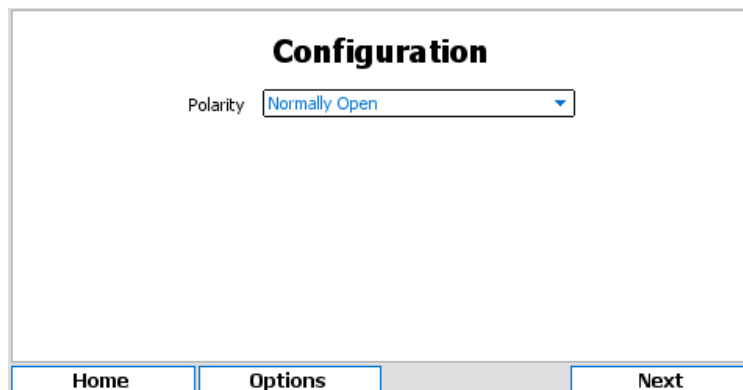

**Polarity** Options are “Normally Open” and “Normally Closed”. The “Next” button is a shortcut to the following configuration screen.

#### 5.2.3.8.3 Relay Selection

This configuration screen is accessed by pressing “Next” from the Configuration screen.

The system status show the state of the device.

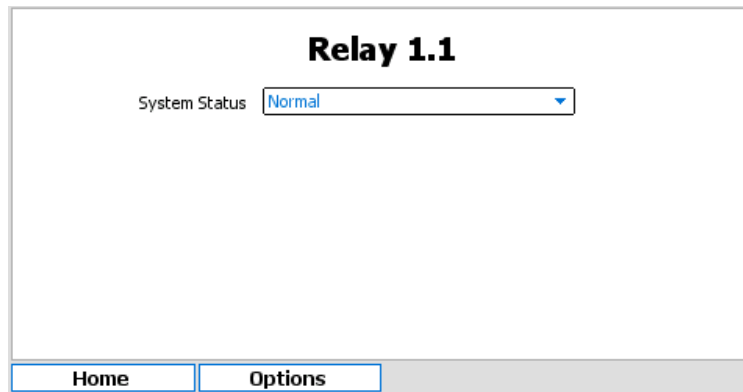

**System Status** Options are “Normal”, “Alarm Active” or “Alarm Acknowledged”

### 5.2.3.9 Status Flags

The status flags show the state of a device. These flags can either be active or not. To see the state of these status flags, select:

Options → Device Flags → Status Flags

Flags that are active are shown in black text on a white background, those that are not active are grayed out. Available flags are:

**Display on main menu** When active the device tile is displayed on the main menu. If inactive, the tile is hidden in the default view.

**Relay polarity** This reflects the relay polarity, if set the relay is normally closed.

**Relay output state** This reflects the relay activation state. Taken together with the relay polarity above, it is possible to determine if the relay is open or closed.

### 5.2.3.10 Error Flags

The error flags show any problems causing an error for a device. These flags can either be active or not. To see the state of these error flags, select:

Options → Device Flags → Error Flags

Flags that are active are shown in black text on a white background, those that are not active are grayed out. Available flags are:

**Output mapping error** This indicates that one of the outputs is mapped incorrectly e.g., mapped to a sensor or control that no longer exists.

### 5.2.3.11 Test Output

It is possible to test a relay. The relays polarity and active state can be manually changed. Leaving this configuration screen will return the relay to its previous state. To do this navigate to:

Options → Test Output

**Relay 1.1**

Polarity  Normally Open  
 Normally Closed

Active  No  
 Yes

Home Options

Options are  
**Polarity** Options are “Normally Open” or “Normally Closed”  
**Active** Options are “No” or “Yes”

### 5.2.3.12 Connections

Options → Connections

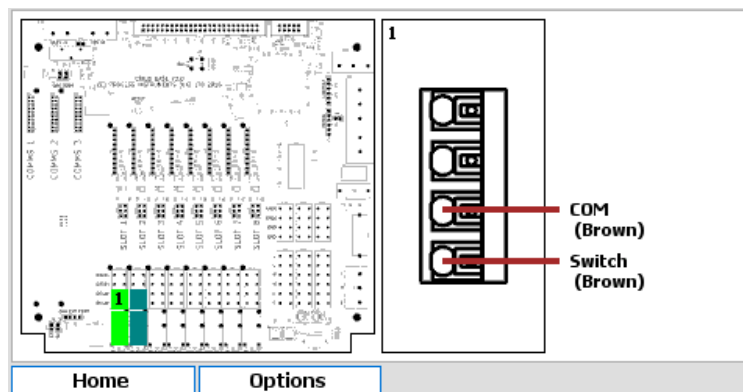

This screen identifies the terminals to use for electrical connections for this relay. The left hand pane identifies the terminal block and the right hand pane the connectors on the terminal block.



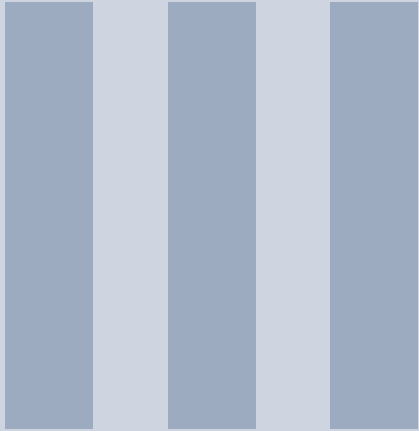

# Documentation

<b>6</b>	<b>Warranty</b> .....	<b>87</b>
<b>7</b>	<b>Returns</b> .....	<b>89</b>
7.1	Contact Details	



## 6. Warranty

Chemtrac, Inc warrants its product to be free of defects in material and workmanship for a period of one year from date of shipment to the original customer unless specifically agreed elsewhere. Upon receipt of written notice from the customer, Chemtrac shall issue a returns form for the defective product and, upon its receipt, shall repair or replace (at the discretion of Chemtrac) the defective equipment or components. Chemtrac assumes no responsibility for equipment damage or failure caused by:

1. Improper installation, operation, or maintenance of the equipment.
2. Abnormal wear and tear on moving parts caused by some processes.
3. Acts of nature (i.e. lightning, flooding, etc.).

This warranty represents the exclusive remedy of damage or failure of the equipment. Under no circumstances shall Chemtrac be liable for any special, incidental, or consequential damage, such as loss of production, profits or product quality. The warranty cannot be guaranteed if the customer fails to service and maintain the equipment in accordance with Chemtrac written instructions and policies, as stated in the Operations Manual.

Any costs associated with this warranty, such as the cost of returning the products to Chemtrac or the cost of returning a repaired unit to the customer lies with the customer. Any warranty replacements will be covered by the warranty, with the same terms and conditions as the original.





## 7. Returns

If the analyzer has to be repaired, please return it cleaned to your local service organization or Chemtrac, Inc at the address below. To return your equipment for repair:

- Contact Chemtrac support, open a service ticket and request a returns form.
- Complete the returns form, including the contaminant declaration.
- Enclose the completed returns form with the packaging and shipping documents.
- Address the package to “The Service Department” at the address below and mark the box with the service ticket number to ensure the package is dealt with as efficiently as possible.
- Please use the original packaging, if possible.

**No repair can be undertaken without a returns form with a completed contaminant declaration. This is required to comply with our Health and Safety responsibilities.**

### 7.1 Contact Details

#### Address

Chemtrac, Inc  
1555 Oakbrook Drive  
Suite 100  
Norcross, GA 30093

**Email** [hardwaresupport@chemtrac.com](mailto:hardwaresupport@chemtrac.com)

**Phone** 800 442 8722